

# /FX- COMM4NDER.®



## DISCLAIMER

---

### **⚠ WARNING**

Read this manual carefully before installing and/or using this product. Failure to read the manual and to follow the printed instructions may lead to personal injury and/or damage to the product.

---

© 2017 MAGICFX®  
All rights reserved.

Nothing from this publication may be copied, reproduced and/or published by means of printing, photocopying or by any other means, without the prior written approval of MAGIC FX.

MAGIC FX reserves the right to modify specifications stated in this manual.

## TRADEMARKS

Any brand names mentioned in this manual are registered trademarks of their respective owners.

## LIABILITY

MAGIC FX accepts no liability for claims from third parties arising from unauthorised use, use other than that stated in this manual, and use other than in accordance with the General Conditions registered at the Chamber of Commerce.

Refer further to the General Conditions. These are available on request, free of charge.

Although considerable care has been taken to ensure a correct and suitably comprehensive description of all relevant components, the manual may nonetheless contain errors and inaccuracies.

Should you detect any errors or inaccuracies in the manual, we would be grateful if you would inform us. This helps us to further improve our documentation.

# TABLE OF CONTENTS

|  |           |
|--|-----------|
| Disclaimer                                   | 2         |
| Trademarks                                   | 2         |
| Liability                                    | 2         |
| Foreword                                     | 4         |
| Language                                     | 4         |
| Revision table                               | 4         |
| <b>1 Meet the MAGICFX® FX-COMM4NDER!</b>     | <b>5</b>  |
| <b>1.1 Main parts</b>                        | <b>5</b>  |
| <b>1.2 Technical data</b>                    | <b>6</b>  |
| <b>1.3 Product identification</b>            | <b>6</b>  |
| <b>1.4 Accessories</b>                       | <b>7</b>  |
| <b>2 Fire safely!</b>                        | <b>8</b>  |
| <b>2.1 General safety rules</b>              | <b>8</b>  |
| <b>2.2 Connecting FX-machines</b>            | <b>8</b>  |
| <b>2.3 Precautions for operation</b>         | <b>8</b>  |
| <b>3 Let's fire!</b>                         | <b>9</b>  |
| <b>3.1 Connect the MAGICFX® FX-COMM4NDER</b> | <b>9</b>  |
| <b>3.2 Fire</b>                              | <b>10</b> |
| <b>3.3 Clean up</b>                          | <b>11</b> |
| <b>4 Maintenance</b>                         | <b>12</b> |
| <b>5 Troubleshooting</b>                     | <b>12</b> |
| <b>6 Correct disposal</b>                    | <b>12</b> |
| <b>7 EC Declaration of Conformity</b>        | <b>13</b> |



## FOREWORD

Congratulations! You have bought a great new product from MAGIC FX.

This manual contains all information required for the intended use of the equipment. Deviation from the described intended use can result in a hazardous situation and/or property damage.

This manual includes notes and warnings on safe operation of the equipment. These notes and warnings are accompanied by the following icons. Read them attentively!

---

|  |   |
|--|---|
|  <b>DANGER</b>  | Indicates a hazardous situation that, if not avoided, will result in death or serious injury. This signal word is to be limited to the most extreme situations. |
|  <b>WARNING</b> | Indicates a hazardous situation that, if not avoided, could result in death or serious injury.  |
|  <b>CAUTION</b> | Indicates a hazardous situation that, if not avoided, could result in minor or moderate injury.   |
| <b>NOTICE</b>  | Indicates information considered important, but not hazard-related (e.g. messages relating to property damage).   |

---

## LANGUAGE

This document contains the original instructions in English. In case you require other languages please contact MAGIX FX.

## REVISION TABLE

| Document nr | Revision | Date       | Description     | Authored by | Checked by |
|-------------|----------|------------|-----------------|-------------|------------|
| PART01174   | 01-00    | 14-11-2017 | Initial version | MBO         | TVA        |

# 1 MEET THE MAGICFX® FX-COMM4NDER!

The MAGICFX® FX-COMM4NDER is a 4 channel controller for 100-250Vac ON/OFF special effects machines. You can fire multiple machines one at a time or simultaneously.

## 1.1 MAIN PARTS

---

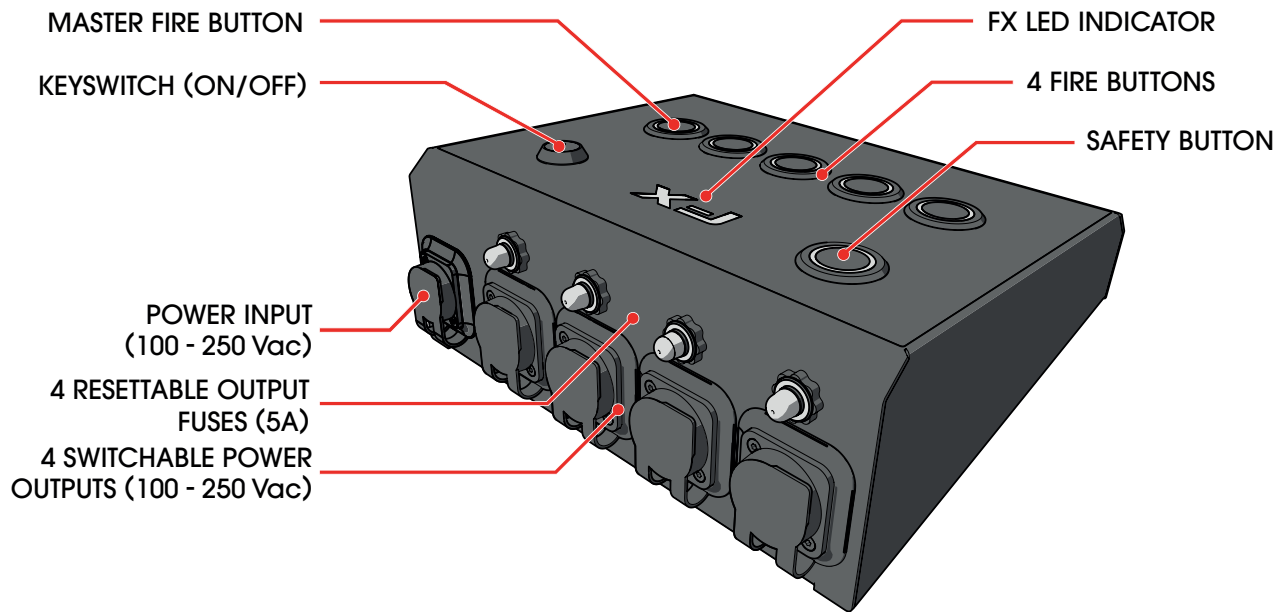

Main parts

## 1.2 TECHNICAL DATA

|                        |                             |   |
|------------------------|-----------------------------|---|
| <b>Product</b>         | Product Name                | MAGICFX® FX-COMM4NDER   |
|                        | Product Code                | MFX3203   |
|                        | Product Type                | Control Gear  |
| <b>Main Dimensions</b> | Length (mm/in.)             | 205 / 8.1   |
|                        | Width (mm/in.)              | 250 / 9.8   |
|                        | Height (mm/in.)             | 102 / 4.0   |
| <b>Weight</b>          | Empty weight (kg/lb.)       | 2.8 / 6.2   |
| <b>Package</b>         | Length (mm/in.)             | 348 / 13.1  |
|                        | Width (mm/in.)              | 303 / 11.4  |
|                        | Height (mm/in.)             | 208 / 7.6   |
|                        | Packaged weight (kg/lb.)    | 3.1 / 6.8   |
| <b>Environment</b>     | Minimum Temperature (°C/°F) | -10 / 14  |
|                        | Maximum Temperature (°C/°F) | 50 / 122  |
| <b>Electrical</b>      | Voltage input (Vac)         | 100-250Vac  |
|                        | Voltage Frequency           | 50-60Hz   |
|                        | Power Consumption (Vac)     | 15W   |
|                        | Power Connector (Vac)       | Neutrik® powerCON TRUE1 (in & 4x out)                         |
|                        | Power Output MAX (Vac)      | 5A per output with resettable output fuse (max. 16A in total) |
| <b>Controlling</b>     | Control Options             | Manual  |

Technical data

## 1.3 PRODUCT IDENTIFICATION

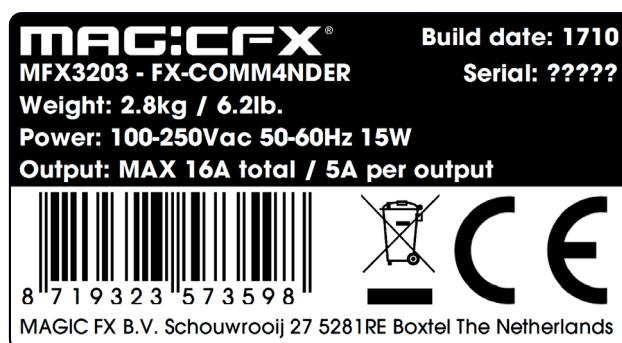

Type plate

## 1.4 ACCESSORIES

| Code    | Product  |
|---------|--|
| MFX0311 | Neutrik® powerCON TRUE1 - Male to Female - Link cable 10m  |
| MFX0312 | Neutrik® powerCON TRUE1 - Male to Female - Link cable 20m  |
| MFX0322 | Neutrik® powerCON TRUE1 - Male to Female - Link cable 0,5m |
| MFX0323 | Neutrik® powerCON TRUE1 - Male to Female - Link cable 1,5m |
| MFX0324 | Neutrik® powerCON TRUE1 - Male to Female - Link cable 3m   |
| MFX0325 | Neutrik® powerCON TRUE1 - Male to Female - Link cable 5m   |
| MFX0326 | Neutrik® powerCON TRUE1 - Male to Female - Link cable 15m  |
| MFX0313 | Schuko to Neutrik® powerCON TRUE1 - cable 1.5m             |

Accessories

## 2 FIRE SAFELY!

The MAGICFX® FX-COMM4NDER has been designed and constructed in such a manner that it can be used safely. This applies to the use, the circumstances and the regulations as described in this documentation. Reading this documentation and following the instructions are therefore necessary for everyone who is authorised to work with the MAGICFX® FX-COMM4NDER.

The MAGICFX® FX-COMM4NDER must be used in surroundings that preferably:

- Have a reasonably stable temperature of between -10 and 50°C.
- Are reasonably free of dust, corrosive gases and high concentrations of organic vapours.
- Are not situated in the vicinity of a source of vibration.

### 2.1 GENERAL SAFETY RULES

- Only authorised persons may carry out work with the MAGICFX® FX-COMM4NDER.
- Do not use the MAGICFX® FX-COMM4NDER if there are people or animals in the direct output of the connected machines.
- Make sure that children, unauthorised people and animals do not obtain access to the MAGICFX® FX-COMM4NDER.
- Make sure there are no freestanding objects or objects that can be damaged by the connected machines within the output distance.
- Do not remove any safeguards, safety caps and safety symbols.
- All required safety devices must be in good condition and function properly.
- Ensure sufficient lighting of the surroundings.
- Keep the workplace clean.
- Refer to the manual(s) of the connected machine(s) for safety instructions concerning the use of those machines.

### 2.2 CONNECTING FX-MACHINES

The voltage and frequency connected to the power input of the FX-SWITCHPACK are also the voltage and frequency of the switchable power outputs. With a maximum electric current per switchable output (see Chapter 1.2 Technical Data), a deviant input voltage or frequency may cause connected FX-machines to not work properly. The switchable output cannot deliver the power the FX-machine might require.

### 2.3 PRECAUTIONS FOR OPERATION

---

**⚠ WARNING**

Using a damaged controller can lead to serious injury and property damage. Always inspect the controller thoroughly before operation.

---

**⚠ WARNING**

Unauthorized operation of the controller can lead to death, serious injury or property damage. Never leave the controller and the power switch unattended when the machine is ready for use.

---



### 3 LET'S FIRE!

#### 3.1 CONNECT THE MAGICFX® FX-COMM4NDER

**⚠ CAUTION**

Do not connect FX-machines to the switchable power output(s) when the output cannot deliver sufficient power to the FX-machine. See Chapter 2.

1 Place the FX-COMM4NDER on a stable surface in a suitable area.

2 Make sure the keyswitch is in the 'OFF' position.

Connect the PowerCon TRUE1 power cable to the controller.

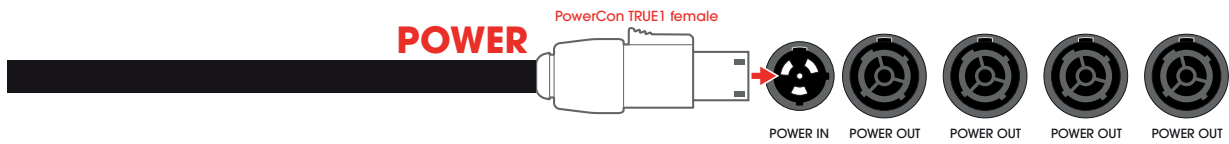
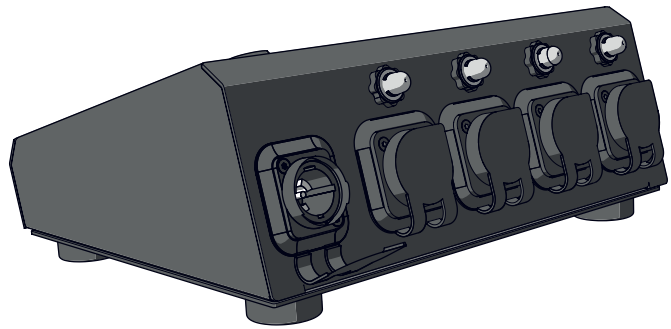

3 Connect the other end to a power outlet.

4 Connect the FX-machines to the FX-COMM4NDER with PowerCon TRUE1 link cables.

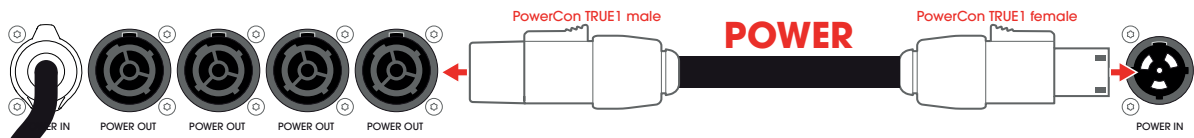
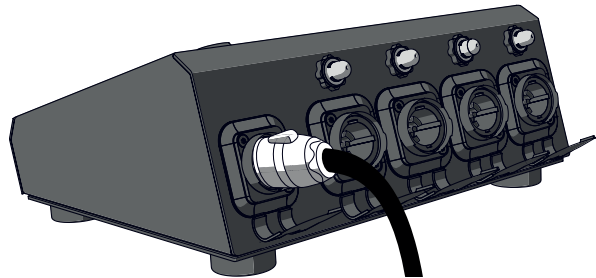

5 Remove the key from the keyswitch when you leave the FX-COMM4NDER unattended.

## 3.2 FIRE

---

- 1 Place the key in the keyswitch and set the keyswitch in the 'ON' position.

All buttons light up white.

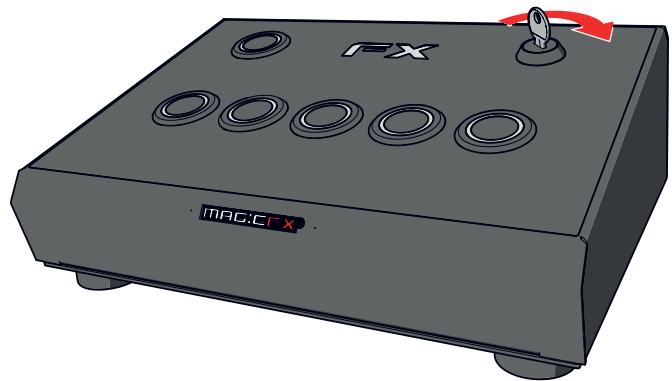

- 2 Press the safety button.

The FX LED indicator and the safety button light up red.

**NOTICE** You cannot press the safety button when other buttons are pressed. Make sure all buttons are released when pressing the safety button.

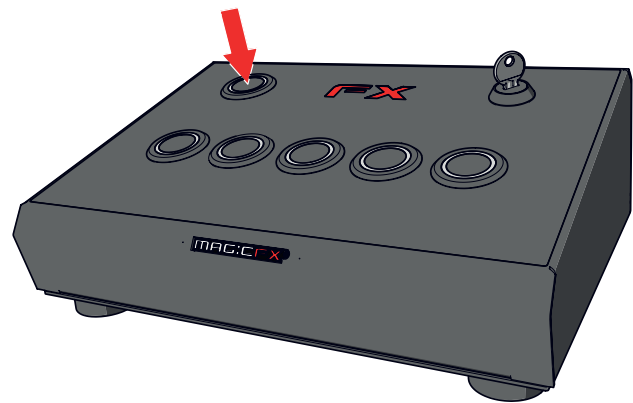

- 3 Press any of the fire buttons to fire the machine connected to the respective output.

The pressed fire button lights up red.

Alternatively, press the master fire button to fire all connected machines simultaneously.

All fire buttons light up red.

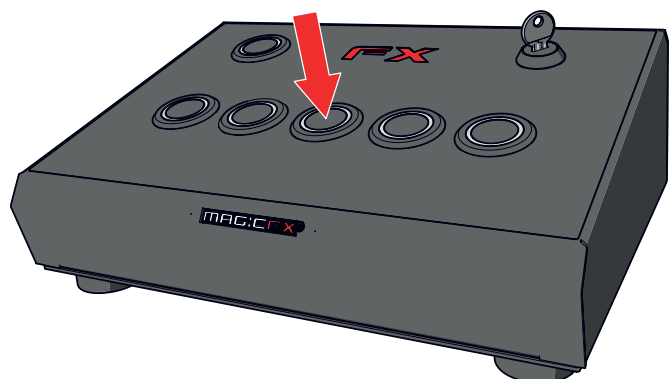

- 4 Enjoy the view!
-

- 
- 5** When you are done with firing, press the safety button to deactivate the fire buttons.

The FX LED indicator turns off.

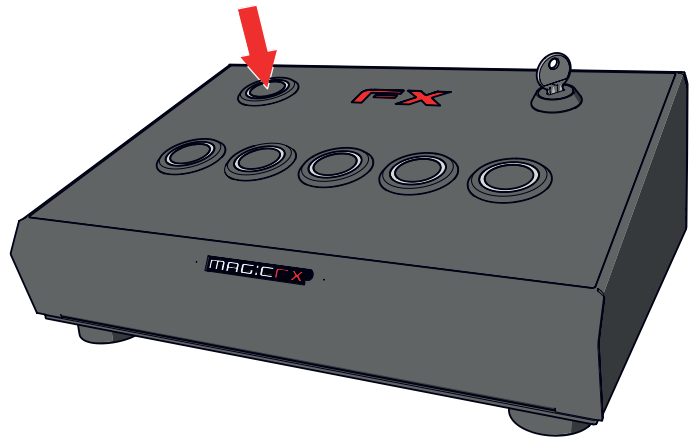

---

### 3.3 CLEAN UP

- 1** Make sure the FX LED indicator is turned off.

Set the keyswitch to the 'OFF' position.

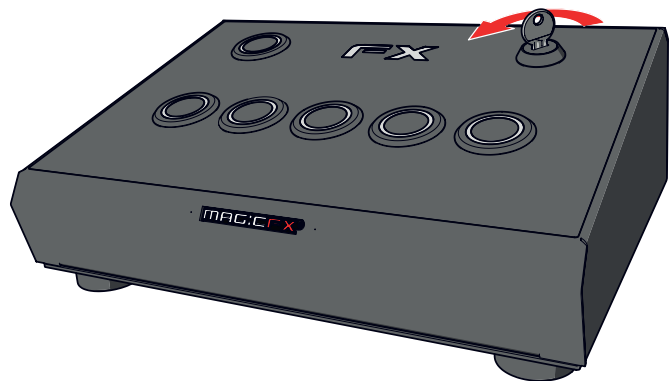

- 
- 2** First disconnect the power cable from the FX-COMM4NDER. Then disconnect the link cables.

- 
- 3** Remove the machine.
-

## 4 MAINTENANCE

To achieve the maximum service life of the MAGICFX® FX-COMM4NDER you must regularly clean the MAGICFX® FX-COMM4NDER and test if it is functioning correctly.

Contact MAGIC FX if the MAGICFX® FX-COMM4NDER is not functioning correctly.

---

**⚠ DANGER**

Do not replace parts yourself; always consult MAGIC FX if necessary.

---

## 5 TROUBLESHOOTING

Always contact MAGIC FX if any malfunctions or errors occur that cannot be solved with the instructions as described in this manual.

## 6 CORRECT DISPOSAL



This symbol on the product and / or accompanying documents means that used electrical and electronic products should not be mixed with general household waste. For proper treatment, recovery and recycling, please take this product to designated collection points where it will be accepted free of charge.

Alternatively, in some countries you may be able to return your products to your local retailer upon purchase of an equivalent new product.

Disposing of this product correctly will help save valuable resources and prevent any potential negative effects on human health and the environment, which could otherwise arise from inappropriate waste handling.

Please contact your local authority for further details of your nearest designated collection point.

Penalties may be applicable for incorrect disposal of this waste, in accordance with your national legislation.

# 7 EC DECLARATION OF CONFORMITY

## According to Annex III A Low Voltage Directive 2014/35/EU

MAGIC FX B.V. declares as manufacturer and composer of the technical construction file that the product with the following specifications:

Name machine : FX-COMM4NDER  
Type : MFX3203  
Voltage : 100-250Vac 50-60Hz  
Serial number : on product  
Year of construction : on product

Is in conformity with the minimal safety regulations as stated in the following directive(s):

- EMC (2014/30/EC) ElectroMagnetic Compatibility
- RoHS (2011/65/EU) Restriction of the use of certain Hazardous Substances
- WEEE (2012/19/EU) Waste Electrical & Electronic Equipment

The following harmonized standards were applied:

- NEN-EN-ISO 12100:2010, Safety of machinery - General principles for design - Risk assessment and risk reduction.
- NEN-EN-IEC 60204:2010, Safety of machinery - Electrical equipment of machines - Part 1: General requirements.
- NEN-EN-IEC 61000-6-3:2007/A1:2011, Electromagnetic compatibility (EMC) - Part 6-3: Generic standards - Emission standard for residential, commercial and light-industrial environments.

- Original declaration of conformity  
 Translation of the original declaration of conformity

Name manufacturer : MAGIC FX BV  
Address : Schouwrooij 27, 5281 RE BOXTEL  
Country : The Netherlands

CEO : B. Veroude  
Date : 6-10-2017

Signature :

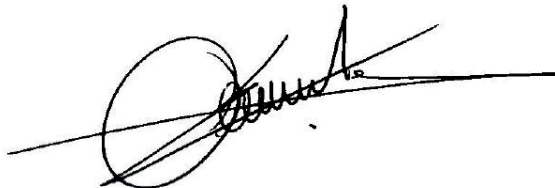

**MAG:CFX<sup>®</sup>**

[WWW.MAGICFX.EU](http://WWW.MAGICFX.EU)

