

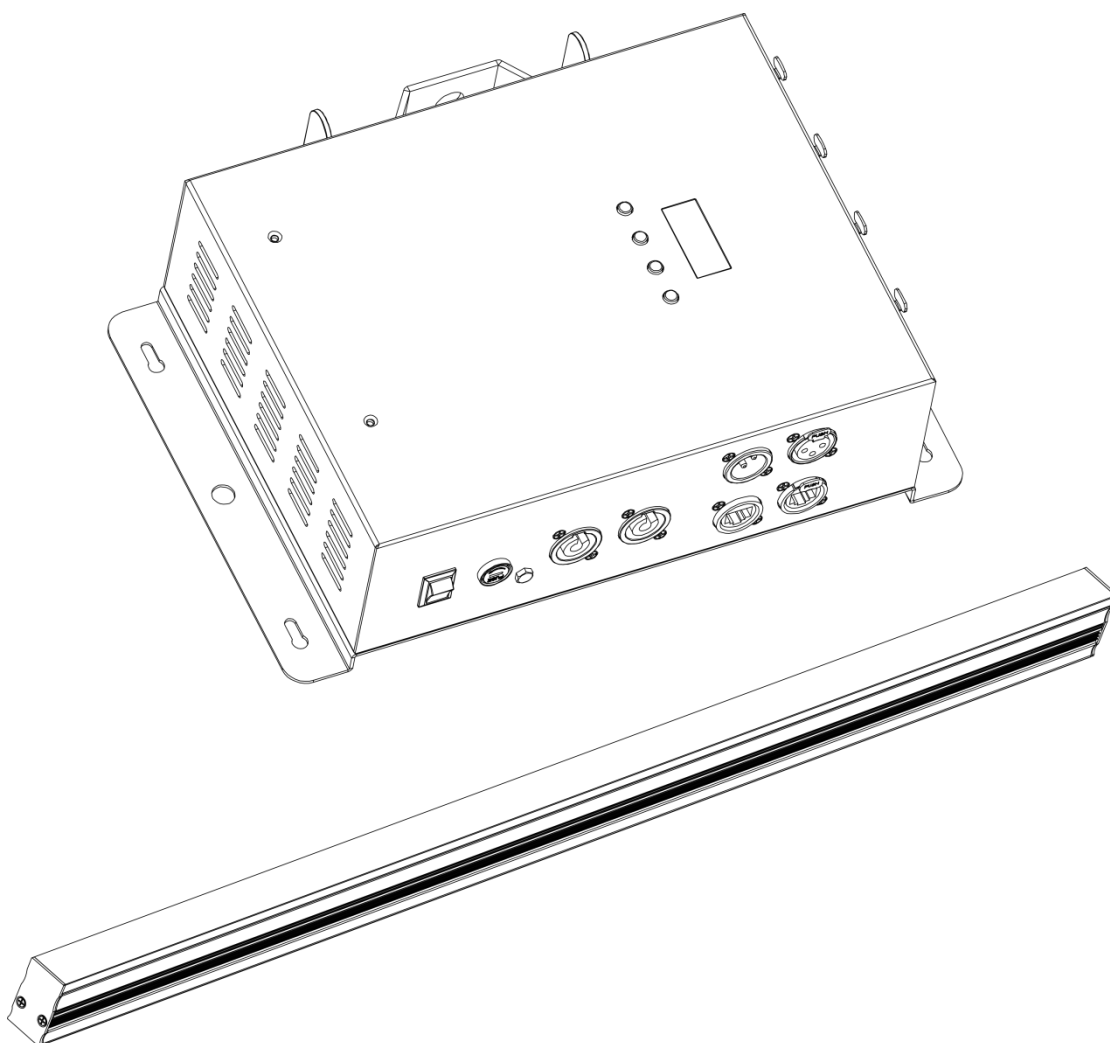

**MANUAL**



**ENGLISH**

**LED Octostrip Set MKII 50 cm**

**V1**

**Ordercode: 42235**

## Table of contents

---

<b>Warning</b> .....	3
Safety Instructions .....	3
Operating Determinations .....	5
Rigging .....	5
Connection with the mains.....	6
Return Procedure.....	6
Claims.....	6
<b>Description of the device</b> .....	7
Overview .....	7
Frontside.....	8
Backside .....	9
<b>Installation</b> .....	9
<b>Set Up and Operation</b> .....	9
Control Modes.....	10
One Octostrip (Auto, Built-in programs, Sound-controlled and Static Color) .....	10
Multiple Octostrips (Master/Slave control) .....	10
Multiple Octostrips (DMX Control) .....	11
Multiple Octostrips (ArtNet Control) .....	12
<b>Connecting to a Network</b> .....	13
ArtNet settings .....	13
How To Make a Data Cable.....	14
Software for controlling .....	14
Fixture Linking.....	15
Data Cabling.....	15
Control Panel.....	16
Control Mode .....	16
DMX Addressing .....	16
Menu Overview .....	17
Main Menu Options .....	18
1. Auto.....	18
2. Built-in Programs.....	18
3. Master/Slave.....	19
4. DMX-512 .....	19
5. Network Settings .....	19
5.1. Signal Source .....	19
5.2. IP Address.....	19
5.3. Net Mask .....	20
5.4. Net .....	20
5.5. Subnet.....	20
5.6. Universe .....	20
5.7. MAC Address.....	20
6. Sound-controlled .....	21
7. Static Colors.....	21
8. Settings.....	21
8.1. LED Mode .....	21
8.2. DMX Error Menu .....	21
8.3. Display Settings .....	21
8.4. Reset .....	21
9. Software Information .....	22
DMX Channels .....	22
6 channels .....	22
8 channels .....	23
14 channels.....	25

24 channels .....28  
26 channels .....29  
50 channels .....34  
96 channels (only when using the 50 cm LED strips) .....43  
112 channels (only when using the 50 cm LED strips) .....44  
192 channels (only when using the 100 cm LED strips) .....46  
208 channels (only when using the 100 cm LED strips) .....47

**Maintenance** .....49  
    Replacing the Fuse .....49

**Troubleshooting** .....49  
    No Light .....49  
    No Response to DMX.....50

**Product Specifications** .....51

**Dimensions** .....52

**Notes** .....53

## Warning



**For your own safety, please read this user manual carefully  
before your initial start-up!**



## Unpacking Instructions

Immediately upon receiving this product, carefully unpack the carton and check the contents to ensure that all parts are present, and have been received in good condition. Notify the dealer immediately and retain packing material for inspection if any parts appear damaged from shipping or the carton itself shows signs of mishandling. Save the carton and all packing materials. In the event that a fixture must be returned to the factory, it is important that the fixture be returned in the original factory box and packing.

## Your shipment includes:

- Showtec LED Octostrip Set MKII 50 cm: controller
- 8 x 50 cm LED strips
- 8 x 5-pin XLR cable (5 m)
- Pro power cable (1,5 m)
- User manual

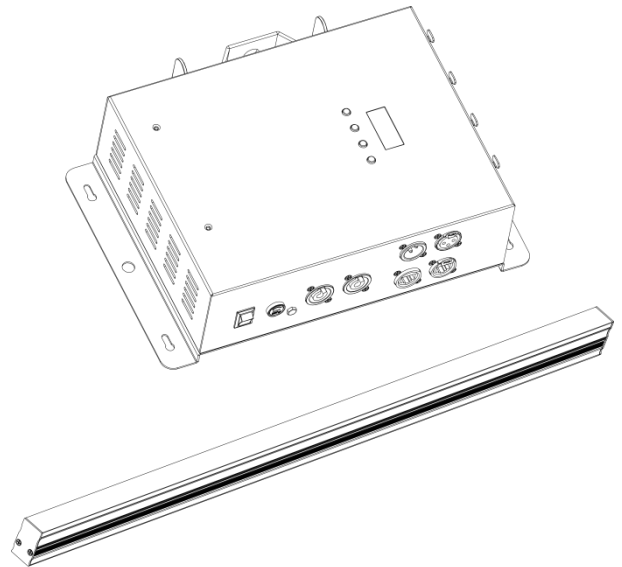

## LED Expected Lifespan

LEDs gradually decline in brightness over time. HEAT is the dominant factor that leads to the acceleration of this decline. Packaged in clusters, LEDs exhibit higher operating temperatures than in ideal or singular optimum conditions. For this reason, when all color LEDs are used at their fullest intensity, life of the LEDs is significantly reduced. If improving the lifespan is of higher priority, place care in providing for lower operational temperatures. This may include climatic-environmental and the reduction of overall projection intensity.



### CAUTION!

**Keep this device away from rain and moisture!  
Unplug mains lead before opening the housing!**



## Safety Instructions

Every person involved with the installation, operation and maintenance of this device has to:

- be qualified
- follow the instructions of this manual



**CAUTION! Be careful with your operations.  
With a dangerous voltage you can suffer  
a dangerous electric shock when touching the wires!**



Before the initial start-up, please make sure that there is no damage caused by transportation. Should there be any, consult your dealer and do not use the device.

To maintain perfect condition and to ensure a safe operation, it is absolutely necessary for the user to follow the safety instructions and warning notes contained in this manual.

Please consider that damages caused by manual modifications to the device are not subject to warranty.

This device contains no user-serviceable parts. Refer servicing to qualified technicians only.

### **IMPORTANT:**

The manufacturer will not accept liability for any resulting damages caused by the non-observance of this manual or any unauthorized modification to the device.

- Never let the power cord come into contact with other cables! Handle the power cord and all connections with the mains with particular caution!
- Never remove warning or informative labels from the unit.
- Never use anything to cover the ground contact.
- Never leave any cables lying around.
- Do not insert objects into air vents.
- Do not connect this device to a dimmer pack.
- Do not switch the device on and off in short intervals, as this will reduce the device's life.
- Do not touch the device's housing bare-handed during its operation (housing becomes very hot). Allow the fixture to cool for at least 5 minutes before handling.
- Do not shake the device. Avoid brute force when installing or operating the device.
- Only use the device indoors, avoid contact with water or other liquids.
- Only operate the fixture after having checked if the housing is firmly closed and all screws are tightly fastened.
- Only operate the device after having familiarized with its functions.
- Avoid flames and do not put close to flammable liquids or gases.
- Always hold the fixture by the transport handles.
- Always keep the case closed while operating.
- Always allow a free air space of at least 50 cm around the unit for ventilation.
- Always disconnect power from the mains, when device is not used or before cleaning! Only handle the power cord holding it by the plug. Never pull out the plug by tugging the power cord.
- Make sure that the device is not exposed to extreme heat, moisture or dust.
- Make sure that the available voltage is not higher than stated on the rear panel.
- Make sure that the power cord is never crimped or damaged. Check the device and the power cord from time to time.
- If device was dropped or struck, disconnect mains power supply immediately. Have a qualified engineer inspect for safety before operating.
- If the device has been exposed to drastic temperature fluctuation (e.g. after transportation), do not switch it on immediately. The arising condensation water might damage your device. Leave the device switched off until it has reached room temperature.
- If your Showtec device fails to work properly, discontinue the use immediately. Pack the unit securely (preferably in the original packing material), and return it to your Showtec dealer for service.
- For adult use only. The fixture must be installed beyond the reach of children. Never leave the unit running unattended.
- Never attempt to bypass the thermostatic switch or fuses.
- The user is responsible for correct positioning and operating of the LED Octostrip. The manufacturer will not accept liability for damages caused by the misuse or incorrect installation of this device.
- This device falls under protection class I. Therefore it is essential to connect the yellow/green conductor to earth.
- Repairs, servicing and electric connection must be carried out by a qualified technician.
- **WARRANTY:** Till one year after date of purchase.



**CAUTION! Eyedamages!!!**  
**Avoid looking directly into the lightsource!!!**  
**(meant especially for epileptics)!!!**



### Operating Determinations

- This device is not designed for permanent operation. Consistent operation breaks will ensure that the device will serve you for a long time without defects.
- The minimum distance between light output and the illuminated surface must be bigger than 1 meter.
- To eliminate wear and improve lifespan, during periods of non-use, completely disconnect from power via breaker or by unplugging.
- The maximum ambient temperature  $t_a = 40^\circ\text{C}$  must never be exceeded.
- The relative humidity must not exceed 50 % with an ambient temperature of  $40^\circ\text{C}$ .
- If this device is operated in any other way than the one described in this manual, the product may suffer damages and the warranty becomes void.
- Any other operation may lead to dangers like short-circuit, burns, electric shock, crash, etc.

*You endanger your own safety and the safety of others!*

### Rigging

*Please follow the European and national guidelines concerning rigging, trussing and all other safety issues.*

*Do not attempt the installation yourself!*

*Always let the installation be carried out by an authorized dealer!*

*Improper installation can cause serious injuries and/or damage of property!*

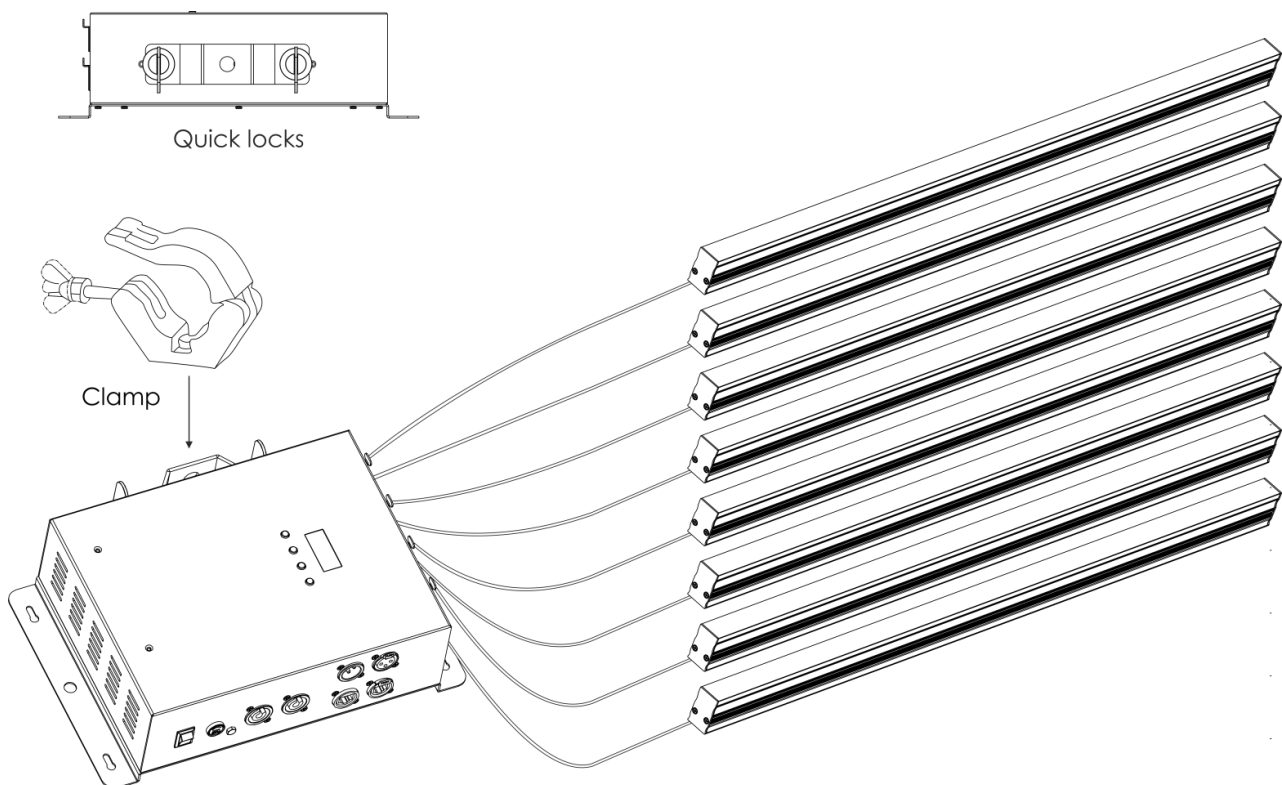

The LED Octostrip Set MKII 50 cm can be placed on a flat stage floor or be mounted to any kind of truss, with a clamp and the included quick locks.

**Connection with the mains**

Connect the device to the mains with the power-plug.  
Always check if the right color cable is connected to the right place.

International	EU Cable	UK Cable	US Cable	Pin
L	BROWN	RED	YELLOW/COPPER	PHASE
N	BLUE	BLACK	SILVER	NEUTRAL
	YELLOW/GREEN	GREEN	GREEN	PROTECTIVE GROUND

*Make sure that the device is always properly connected to the earth!*

*Improper installation can cause serious injuries and/or damage of property!*



 **Return Procedure** 

Returned merchandise must be sent prepaid and in the original packing, call tags will not be issued. Package must be clearly labeled with a Return Authorization Number (RMA number). Products returned without an RMA number will be refused. Highlite will not accept the returned goods or any responsibility. Call Highlite 0031-455667723 or mail [offersales@highlite.nl](mailto:offersales@highlite.nl) and request an RMA prior to shipping the fixture. Be prepared to provide the model number, serial number and a brief description of the cause for the return. Be sure to properly pack fixture, any shipping damage resulting from inadequate packaging is the customer's responsibility. Highlite reserves the right to use its own discretion to repair or replace product(s). As a suggestion, proper UPS packing or double-boxing is always a safe method to use.

**Note: If you are given an RMA number, please include the following information on a piece of paper inside the box:**

- 01) Your name
- 02) Your address
- 03) Your phone number
- 04) A brief description of the symptoms

**Claims**

The client has the obligation to check the delivered goods immediately upon delivery for any shortcomings and/or visible defects, or perform this check after our announcement that the goods are at their disposal. Damage incurred in shipping is the responsibility of the shipper; therefore the damage must be reported to the carrier upon receipt of merchandise.

It is the customer's responsibility to report and submit claims with the shipper in the event that a fixture is damaged due to shipping. Transportation damage has to be reported to us within one day after receipt of the delivery.

Any return shipment has to be made post-paid at all times. Return shipments must be accompanied with a letter defining the reason for return shipment. Non-prepaid return shipments will be refused, unless agreed otherwise in writing.

Complaints against us must be prepared in writing or sent by fax within 10 working days after receipt of the invoice. After this period complaints will not be handled anymore.

Complaints will only then be considered if the client has so far complied with all parts of the agreement, regardless of the agreement from which the obligation is resulting.



## Description of the device

### Features

The LED Octostrip MKII 50 cm is a complete plug-and-play set; consisting of 8 LED strips, a controller and eight 5-meter long XLR extension cables. The new LED Octostrip can control each strip's 8 individual RGB sections, along with the corresponding dimmer and strobe settings. The device supports ArtNet protocol, which facilitates the use of device while operating in the full RGB mode (192CH mode). The updated color presets and many versatile built-in color flows, in horizontal and vertical directions, are accessible via DMX (in 6CH, 8CH, 14CH, 24CH, 26CH and 50CH channel modes).



It is possible to connect the Octostrip MKI to the new Octostrip MKII 50 cm. However, in such case, it is not advisable to operate the old and the new version of the device in Auto mode, as the built-in programs differ per version.



- Power supply: 100-240V AC, 50/60Hz
- Power consumption: 52W (full output)
- Control protocol: DMX-512, ArtNet
- Built-in programs: 21 programs
- DMX channels: 6, 8, 14, 24, 26, 50, 96, 112, 192, 208 channels
- Maximum cable length: 5 m
- Connectors: Pro power connector, 3-pin XLR IN/OUT, 5-pin XLR LED strip OUT, ArtNet RJ45 IN/OUT
- Control modes: Auto, Built-in programs, Sound-controlled, Static Colors, Master/Slave, DMX/ArtNet
- Cooling: Convection
- Dimmer: 0-100%
- Strobe: 0-20Hz
- Housing: Die-cast aluminum
- Color: Black
- IP rating: IP20
- Fuse: T2L/250V
- Dimensions (controller): 200 x 315 x 92 mm (LxWxH)
- Dimensions (LED strip): 500 x 30 x 50 mm (LxWxH)
- Weight (controller): 2,5 kg
- Weight (8 x LED strips): 8 x 0,8 kg

Note: It is possible to purchase a separate LED Octostrip controller, to create more flexibility.

### Optional accessories:

[42233](#) – Showtec Controller for Octostrip MKII

### Overview

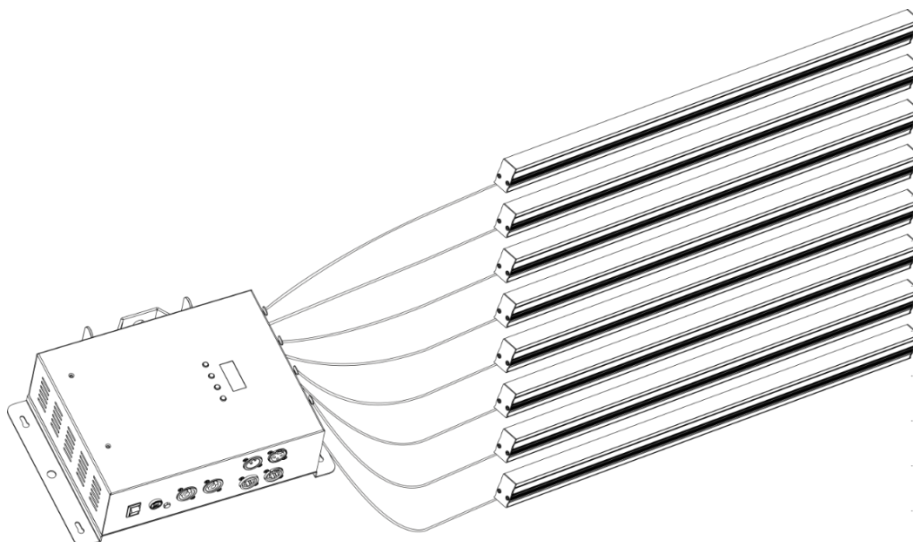

Fig. 01



Frontside

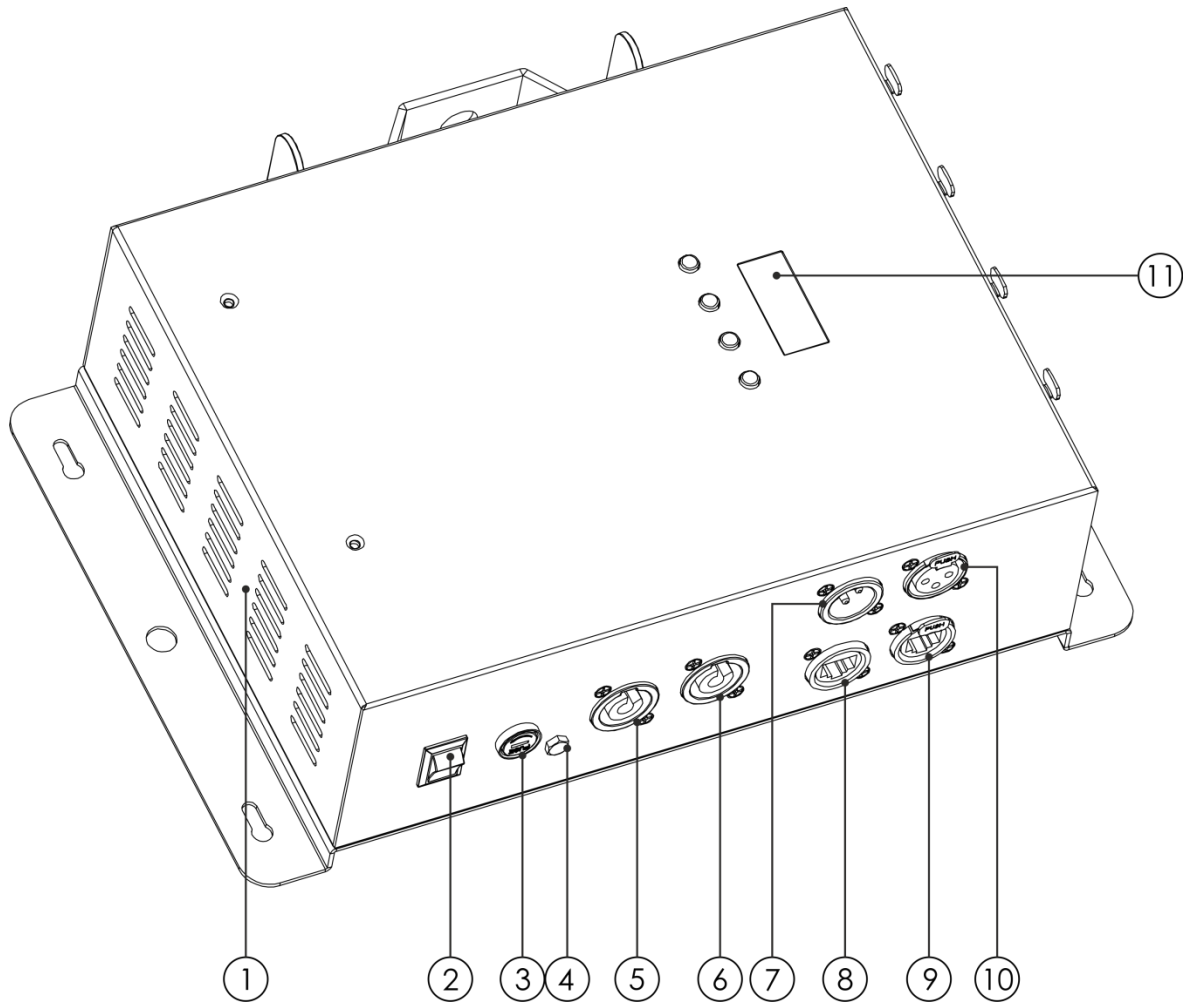

Fig. 02

- 01) Air intake grill
- 02) Power switch ON/OFF
- 03) Fuse T2L/250V
- 04) Ground/earth connection
- 05) Pro power connector Blue 100-240V IN
- 06) Pro power connector Grey 100-240V OUT
- 07) 3-pin DMX signal connector IN
- 08) RJ45 ArtNet signal connector IN
- 09) RJ45 ArtNet signal connector OUT
- 10) 3-pin DMX signal connector OUT
- 11) LED display + control buttons

Backside

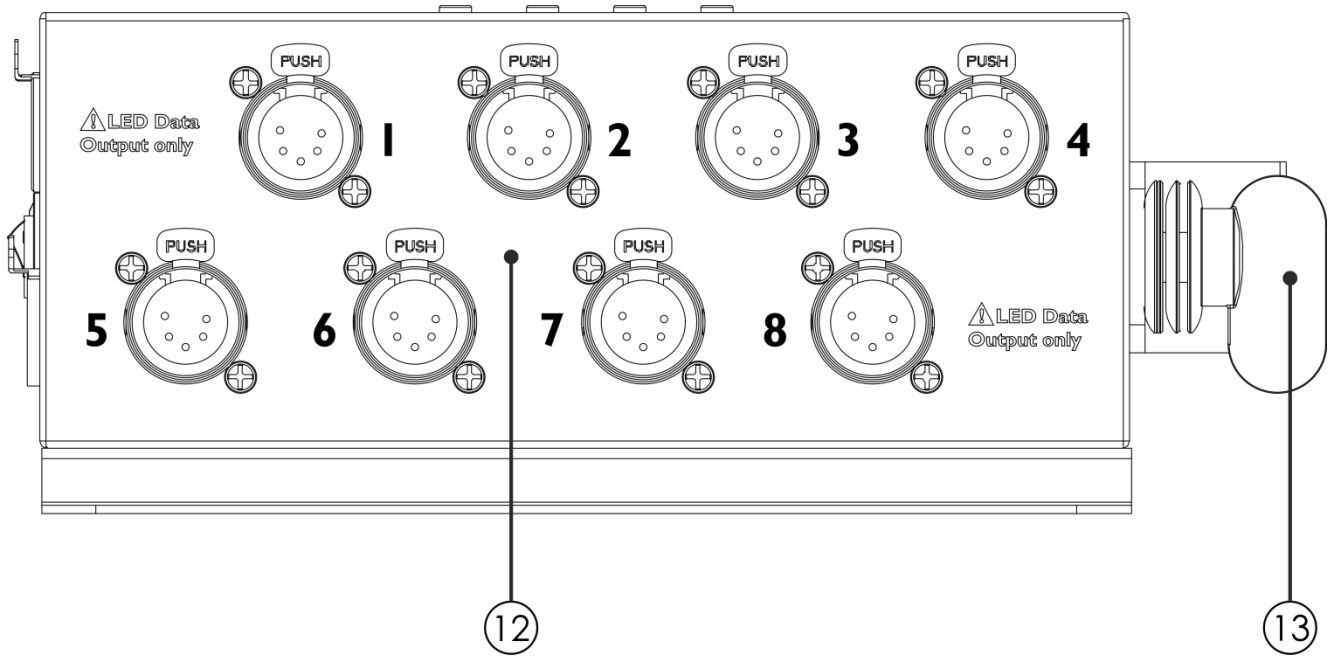

Fig. 03

- 12) 5-pin XLR LED Octostrip MKII 1-8 OUT
- 13) Mounting bracket + quick locks

Installation

Remove all packing materials from the LED Octostrip Set MKII 50 cm. Check if all foam and plastic padding is removed. Connect all cables.

**Do not supply power before the whole system is set up and connected properly.**

**Always disconnect from electric mains power supply before cleaning or servicing.**

**Damages caused by non-observance are not subject to warranty.**

Set Up and Operation

Follow the directions below, as they pertain to your preferred operation mode.

Before plugging the unit in, always make sure that the power supply matches the product specification voltage. Do not attempt to operate a 120V specification product on 230V power, or vice versa.

Connect the device to the main power supply.

## Control Modes

- There are 6 modes:
- Auto Mode
  - Built-in programs
  - Sound-controlled
  - Static Colors
  - Master/Slave
  - DMX-512, ArtNet (6CH, 8CH, 14CH, 24CH, 26CH, 50CH, 96CH, 112CH, 192CH, 208CH)

### One Octostrip (Auto, Built-in programs, Sound-controlled and Static Color)

- 01) Fasten the effect light to a firm trussing. Leave at least 0,5 meter on all sides for air circulation.
- 02) Plug the end of the electric mains power cord into a proper electric power supply socket.
- 03) When the Octostrip is not connected by means of a DMX cable, it functions as a stand-alone device. When the Octostrip is operating in Sound-controlled mode, it will react to the beat of the background music.
- 04) Please see pages 18 and 21 for more information about Auto, Built-in programs, Sound-controlled and Static Colors modes.

### Multiple Octostrips (Master/Slave control)

- 01) Fasten the effect light onto firm trussing. Leave at least 0,5 meter on all sides for air circulation.
- 02) Use a 3-pin XLR cable to connect the Octostrips.

The pins:



- 01) Earth
- 02) Signal -
- 03) Signal +

- 03) Link the units as shown in fig. 04. Connect the first unit's DMX "out" socket with the second unit's "in" socket, using a DMX signal cable. Repeat this process to link the second, third, and fourth units.
- 04) Connect the included 8 LED strips to the Octostrip's 5-pin XLR "out" sockets.
- 05) You can use the same functions on the master device as described on pages 18 and 21 (Auto, Built-in programs, Sound-controlled and Static Colors). You can set your desired operation mode on the master device and all slave devices will react the same as the master device.

### Multiple Octostrips (Master/Slave control)

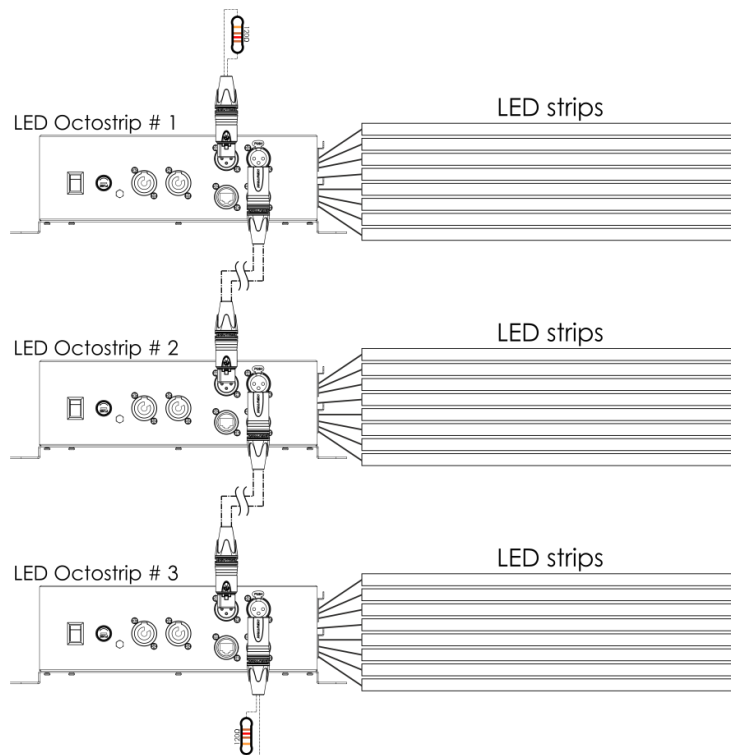

Fig. 04

## Multiple Octostrips (DMX Control)

- 01) Fasten the effect light to a firm trussing. Leave at least 0,5 meter on all sides for air circulation.
- 02) Always use a safety cable (ordercode 70140 / 70141).
- 03) Use a 3-pin XLR cable to connect the Octostrips and other devices.



- 04) Link the units as shown in fig. 05. Connect the first unit's DMX "out" socket with the second unit's "in" socket, using a DMX signal cable. Repeat this process to link the second, third, and fourth units.
- 05) Connect a light controller to the first device's "in" socket, using a DMX cable.
- 06) Connect the included 8 LED strips to the Octostrip's 5-pin XLR "out" sockets.
- 07) Supply electric power: Plug electric mains power cords into each unit's Pro power socket, then plug the other end of the mains power cord into proper electric power supply sockets, starting with the first unit. Do not supply power before the whole system is set up and connected properly.

## Multiple Octostrips DMX Set Up

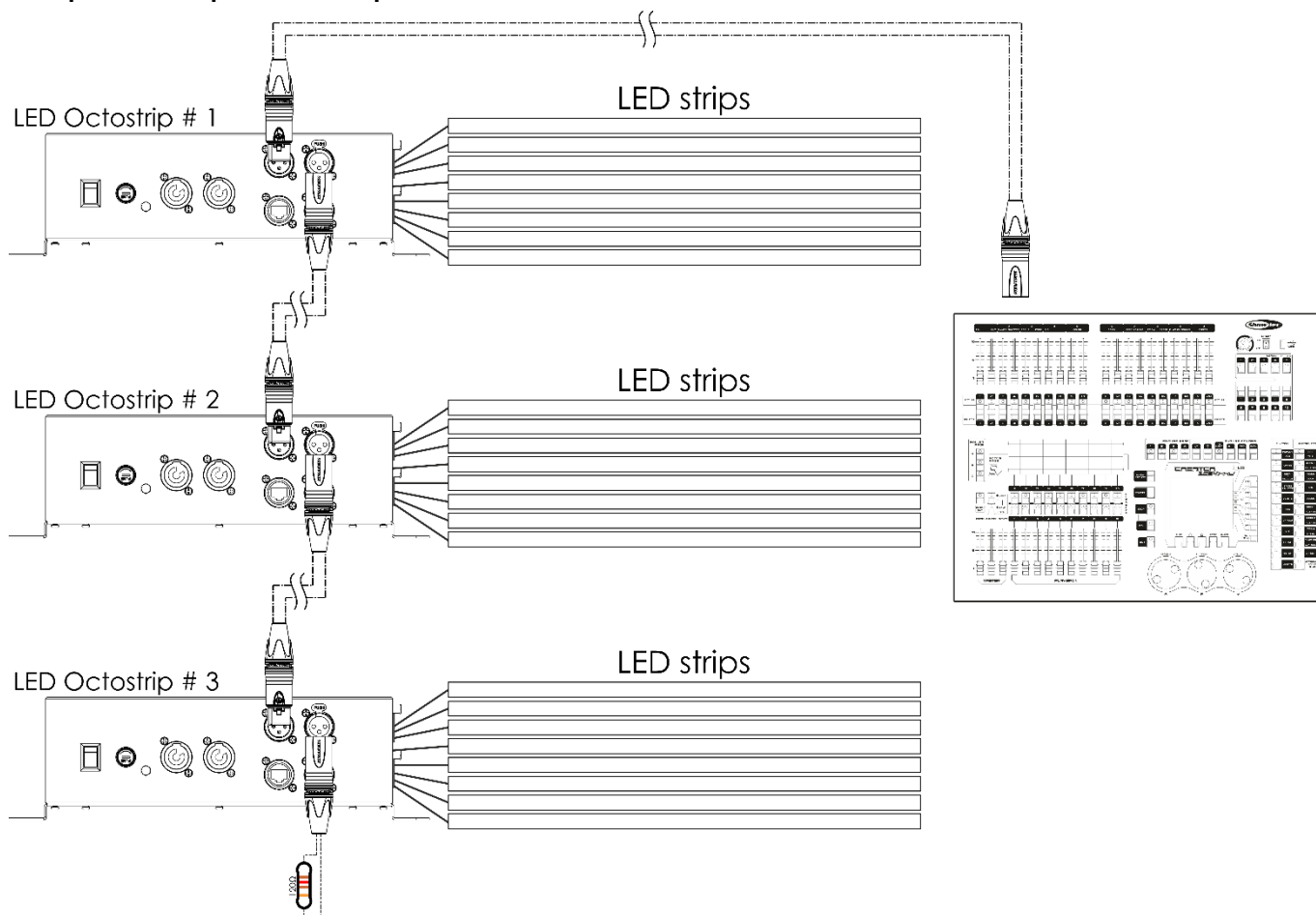

Note : Link all cables before connecting electric power

Fig. 05

## Multiple Octostrips (ArtNet Control)

- 01) Fasten the effect light to a firm trussing. Leave at least 0,5 meter on all sides for air circulation.
- 02) Always use a safety cable (ordercode 70140 / 70141).
- 03) Use a CAT-5/CAT-6 cable to connect the Octostrips and other ArtNet devices.
- 04) Link the units as shown in fig. 06. Connect the first Octostrip's RJ45 "out" socket with the second unit's "in" socket, using a CAT-5/CAT-6 signal cable. Repeat this process to link the second, third, and fourth units.
- 05) Using a CAT-5/CAT-6 cable, connect the first Octostrip's RJ45 "in" socket to the PC (Windows or Mac) with installed ArtNet software.
- 06) Supply electric power: Plug electric mains power cords into each unit's Pro power socket, then plug the other end of the mains power cord into proper electric power supply sockets, starting with the first unit. Do not supply power before the whole system is set up and connected properly.

## Multiple Octostrips ArtNet Set Up

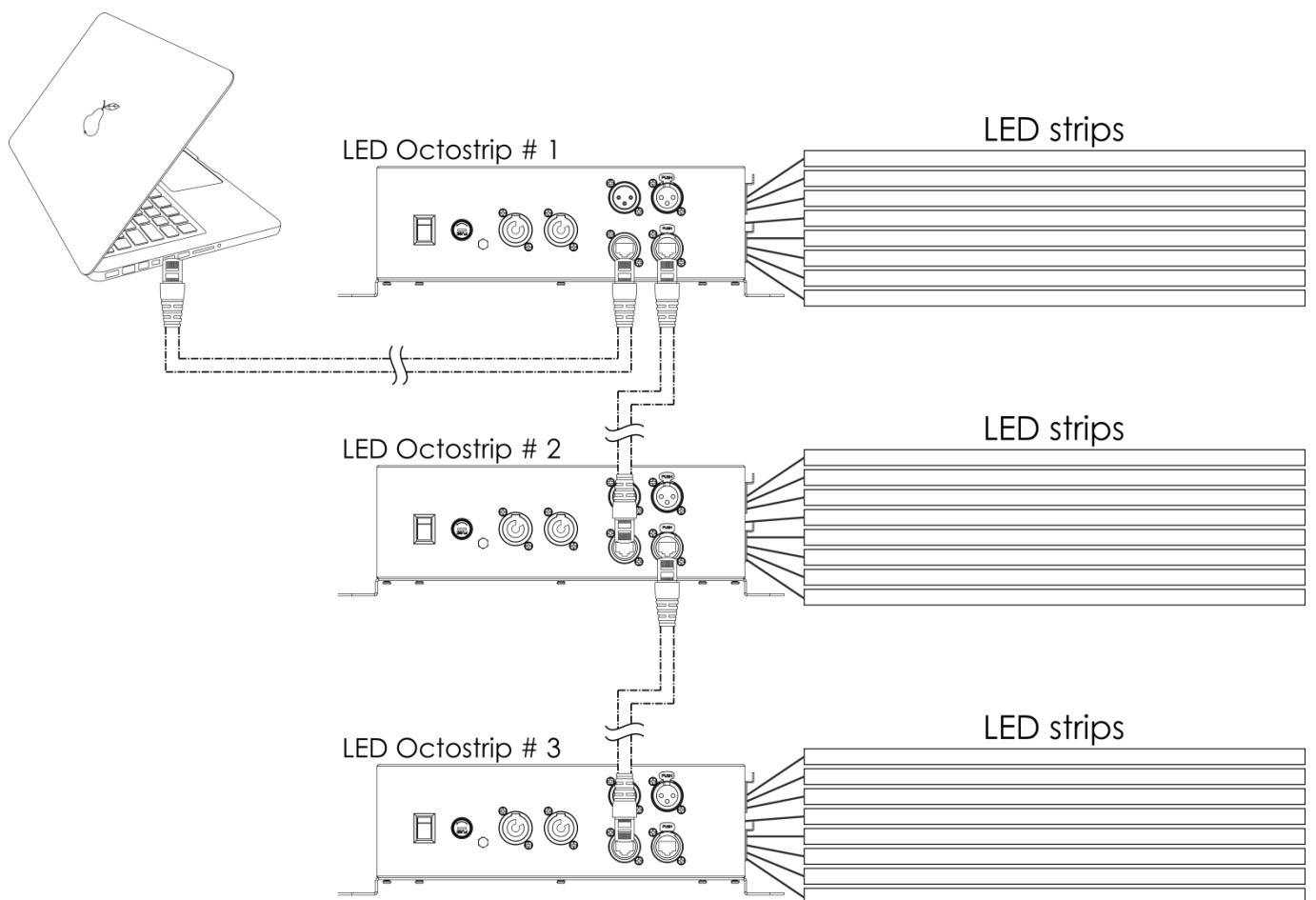

Fig. 06

**Note : Link all cables before connecting electric power**

## Connecting to a Network

---

### ArtNet settings

- 01) Install any ArtNet-based software on your PC (Windows or Mac) or use a light controller which supports ArtNet.
- 02) Connect the LED strips to the Octostrip controller.
- 03) Connect the power supply to the Octostrip.
- 04) Connect the device's Ethernet connector to your software/light controller's Ethernet connector. Use a CAT-5/CAT-6 cable.
- 05) Set the IP address of your software/light controller to **2.x.x.x** or **10.x.x.x**, depending on the ArtNet settings.
- 06) Set the subnet mask to **255.0.0.0** on both – the Octostrip controller and your software/light controller. Make sure that all the fixtures in the network have a **unique IP address**.
- 07) If you want to connect more than one fixture, follow the example below.

### Example:

- 01) Make sure that each connected Octostrip has a **unique IP address**.
- 02) Make sure that the subnet mask on each device is set to **255.0.0.0**.
- 03) Set the universe of the first Octostrip to **1**.
- 04) Set the first Octostrip's DMX address to **001**.
- 05) If you , for example, want to operate the Octostrip in 8CH mode, set the DMX starting address of the second Octostrip to **9**, third – **17**, etc.
- 06) Once you have reached the limit of 512 DMX addresses, set the universe of the next Octostrip to **2**. In this way, you again have 512 DMX channels to work with and you are able to connect many more devices.
- 07) When connecting multiple Octostrips, you can repeat steps 3-6 up to 15 times, each time inserting ascending universe numbers (as there are 15 universes available).
- 08) If you want to connect even more devices, set the net value of the next Octostrip to **2**.
- 09) Repeat steps 3-7 until you reach the net limit (each separate net is equipped with 15 universes. There are 127 nets in total. The number of nets depends on the software you use). Using your software (for example **102101** - Arkaos Media Master Express), map all the connected devices, using the settings described above.
- 10) The Octostrips are now ready for use.
- 11) When creating large setups, it is recommended to use a 16-bit, high speed ethernet switch to distribute the ArtNet data signal.

## How To Make a Data Cable

A standard ETHERNET cable can be used to replace the data cable required to transmit the data for the LED Octostrip MKII 50 cm.

**Please follow the instructions below in order to create an extra net cable.**

Take a standard net cable (CAT-5/ 5E /6) and connect it to the RJ45 connector, as shown in the picture below (fig. 07). The wires should now be colored as follows:

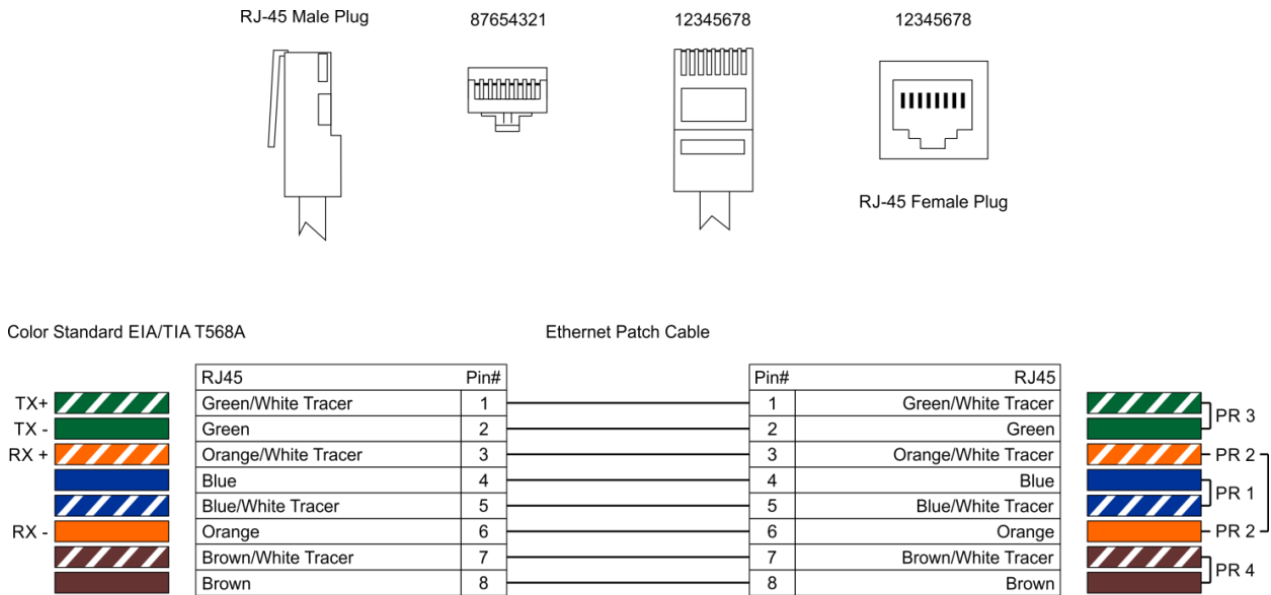

**Fig. 07**

## Software for controlling

In combination with Arkaos or DMT Software, you are able to play videos over the LED Octostrip MKII. You only have to connect all the Octostrips and run your software.

### [102101](#)

Arkaos Media Master Express 5.0

The latest update of the successful media server software.

### [102201](#)

Arkaos Media Master Pro 5.0

PRO DMX video software for lighting designers.



## Fixture Linking

You will need a serial data link to run light shows of one or more fixtures using a DMX-512 controller or to run synchronized shows of two or more fixtures set to a master/slave operating mode. The combined number of channels required by all the fixtures on a serial data link determines the number of fixtures the data link can support.

**Important:** Fixtures on a serial data link must be daisy-chained in a single line. To comply with the EIA-485 standard, no more than 30 devices should be connected on one data link. Connecting more than 30 fixtures on one serial data link without the use of a DMX optically isolated splitter may result in deterioration of the digital DMX signal.  
Maximum recommended DMX data link distance: 100 meters  
Maximum recommended number of fixtures on a DMX data link: 30 fixtures



## Data Cabling

To link fixtures together, you must obtain data cables. You can purchase DAP Audio certified DMX cables directly from a dealer/distributor or construct your own cable. If you choose to create your own cable, please use data-grade cables that can carry a high quality signal and are less prone to electromagnetic interference.

### DAP Audio DMX Data Cables

- DAP Audio Basic microphone cable for allround use. bal. XLR/M 3-pin > XLR/F 3-pin. **Ordercode** FL01150 (1,5 m), FL013 (3 m), FL016 (6 m), FL0110 (10 m), FL0115 (15 m), FL0120 (20 m).
- DAP Audio X-type data cable XLR/M 3-pin > XLR/F 3-pin. **Ordercode** FLX0175 (0,75 m), FLX01150 (1,5 m), FLX013 (3 m), FLX016 (6 m), FLX0110 (10 m).
- DAP Audio cable for the demanding user with exceptional audio-qualities and connector made by Neutrik®. **Ordercode** FL71150 (1,5 m), FL713 (3 m), FL716 (6 m), FL7110 (10 m).
- DAP Audio cable for the demanding user with exceptional audio-qualities and connector made by Neutrik®. **Ordercode** FL7275 (0,75 m), FL72150 (1,5 m), FL723 (3 m), FL726 (6 m), FL7210 (10 m).
- DAP Audio 110 Ohm cable with digital signal transmission. **Ordercode** FL0975 (0,75 m), FL09150 (1,5 m), FL093 (3 m), FL096 (6 m), FL0910 (10 m), FL0915 (15 m), FL0920 (20 m).
- DAP Audio data cable FL08 DMX/AES-EBU, XLR/M 5-pin > XLR/F 5-pin. **Ordercode** FL08150 (1,5 m), FL083 (3 m), FL086 (6 m), FL0810 (10 m), FL0820 (20 m).
- DAP Audio DMX adapter: 5-pin/3-pin. **Ordercode** FLA29.
- DAP Audio DMX adapter: 3-pin/5-pin. **Ordercode** FLA30.

### DAP Audio PC Interface Cables

- CAT-5 cable 7,6 mm Matte blue PVC. **Ordercode** FL55150 (1,5 m), FL553 (3 m), FL556 (6 m), FL5510 (10 m), FL5515 (15 m), FL5520 (20 m).
- CAT-6 cable (recommended for best data transfer). **Ordercode** FL563 (3 m), FL566 (6 m), FL5610 (10 m), FL5615 (15 m), FL5640 (40 m).

The LED Octostrip Set MKII 50 cm can be operated with a light controller in **control mode** or without the controller in **stand-alone mode**.

## Control Panel

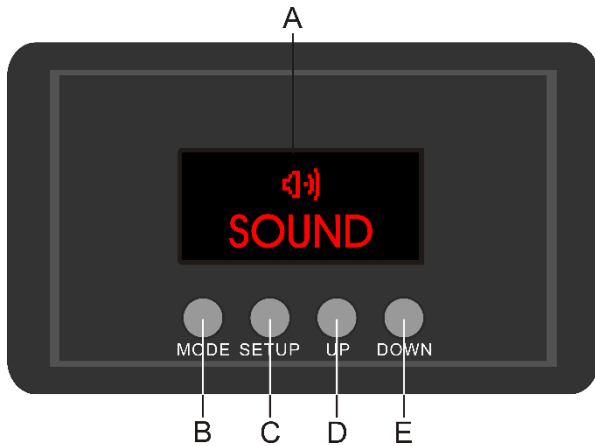

- A) LCD display
- B) MODE button
- C) SETUP button
- D) UP button
- E) DOWN button

Fig. 08

## Control Mode

The fixtures are individually addressed on a data-link and connected to the controller. The fixtures respond to the DMX signal from the controller. (When you select the DMX address and save it, the controller will display the saved DMX address, next time.)

## DMX Addressing

The control panel on the front side of the base allows you to assign DMX fixture addresses, which is the first channel with which the Octostrip will respond to the controller.

Please note, when you use the controller, the unit has **208** channels.

When using multiple Octostrips, make sure you set the DMX addresses right.

Therefore, the DMX address of the first Octostrip should be **1(001)**; the DMX address of the second Octostrip should be **1+208=209 (209)**. The DMX address of the third Octostrip should be **209+208=417 (417)**, etc. Please, be sure that you do not have any overlapping channels in order to control each Octostrip correctly. If two Octostrips are addressed similarly, they will work similarly.

**Note:** It is also possible to connect multiple devices by means of ArtNet. See page 13 for more information.

## Controlling:

After having addressed all Octostrip fixtures, you may now start operating these via your lighting controller.

**Note:** After switching on, the Octostrip will automatically detect whether DMX 512 data is received or not.

If there is no data received at the DMX-input, the "LED " on the control panel will not flash.

If not, the problem may be:

- The XLR cable from the controller is not connected with the input of the LED Octostrip MKII 50 cm.
- The controller is switched off or defective, the cable or connector is defective, or the signal wires are swapped in the input connector.

**Note:** It is necessary to insert an XLR termination plug (with 120 Ohm) in the last fixture in order to ensure proper transmission on the DMX data link.

## Display Off after 60 seconds

When no button is pressed for 60 seconds, the display will turn off.







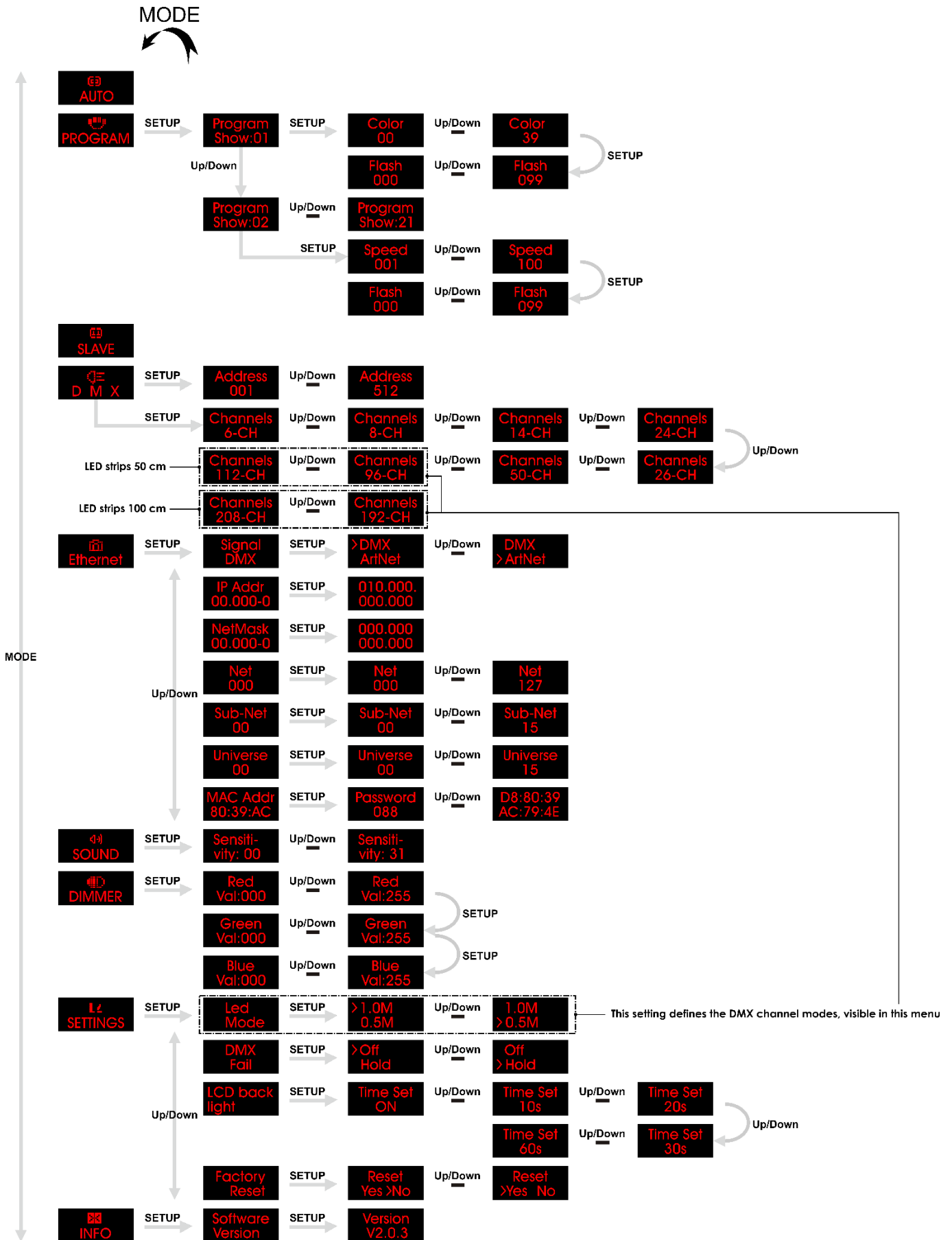

To light up the display, you have to press the MODE, SETUP, UP or DOWN button.

Once you have pressed the button, the display will light up.

## Menu Overview



## Main Menu Options

	Auto
	Built-in Programs
	Master/Slave
	DMX-512
	Network Settings
	Sound-controlled
	Static Colors
	Settings
	Software Information















### 1. Auto

With this menu, you can set Auto mode.

- 01) Press the **MODE** button until the display shows .
- 02) The device will now run all built-in programs in sequence.

### 2. Built-in Programs

With this menu, you can set the built-in programs.

- 01) Press the **MODE** button until the display shows .
- 02) Press the **SETUP** button to open the menu.
- 03) Press the **UP/DOWN** buttons to choose the desired built-in program. The adjustment range is between   .
- 04) Press the **UP/DOWN** buttons until the display shows .
- 05) Press the **SETUP** button to enter and to toggle between the 2 options below. Once you have chosen the desired option, do as follows:
  -    Color (Press the **UP/DOWN** buttons to choose one of the 39 color presets.)
  -    Strobe (Press the **UP/DOWN** buttons to set strobe frequency. The adjustment range is between 0-99, from OFF to high frequency.)
- 06) Once you have adjusted the settings, press the **SETUP** button to confirm.
- 07) Return to step 4 and choose one of the programs from the range:   .

08) Press the **SETUP** button to enter and to toggle between the 2 options below. Once you have chosen the desired option, do as follows:

Speed  
001

Up/Down

Speed  
100

Program speed (Press the **UP/DOWN** buttons to increase/decrease program speed. The adjustment range is between 1-100, from slow to fast.)

Flash  
000

Up/Down

Flash  
099

Strobe (Press the **UP/DOWN** buttons to set strobe frequency. The adjustment range is between 0-99, from OFF to high frequency.)

09) Once you have adjusted the settings, press the **SETUP** button to confirm.

### 3. Master/Slave

With this menu you can set the device as a master or a slave device.

01) Press the **MODE** button until the display shows  SLAVE .

02) The device is now operating in slave mode and will react the same as the master device.

### 4. DMX-512

With this menu you can set the device's DMX starting address and the desired DMX channel mode.

01) Press the **MODE** button until the display shows  D M X .

02) Press the **SETUP** button to open the menu.

03) Press the **UP/DOWN** buttons to set the desired DMX starting address. The adjustment range is between  Address 001   Address 512 .

04) Press the **SETUP** button again to proceed to channel mode settings.

05) Press the **UP/DOWN** buttons to choose one of the following DMX channel modes:

- 6CH, 8CH, 14CH, 24CH, 26CH, 50CH, 96CH or 112CH (**for 50 cm LED strips**)
- 6CH, 8CH, 14CH, 24CH, 26CH, 50CH, 192CH or 208CH (**for 100 cm LED strips**)

06) The displayed DMX channel modes depend on the LED strip length. See 8.1., page 21.

07) Press the **SETUP** button to confirm.

### 5. Network Settings

With this menu, you can adjust the device's properties, such as the signal source, IP address, net mask, net, subnet mask, universe and the MAC address.

01) Press the **MODE** button until the display shows  Ethernet .

02) Press the **SETUP** button to open the menu.

03) Press the **UP/DOWN** buttons to toggle through the 7 options below.

#### 5.1. Signal Source

With this menu you can select the desired signal source: DMX or ArtNet.

01) Press the **UP/DOWN** buttons until the display shows  Signal DMX .

02) Press the **SETUP** button to open the menu.

03) Press the **UP/DOWN** buttons to choose between DMX or ArtNet.

04) Press the **SETUP** button to confirm.



If you have chosen ArtNet, press the **MODE** button until the display shows  D M X , for the signal to be received properly. **Otherwise, the device will not function in ArtNet mode.**



#### 5.2. IP Address

With this menu you can set the IP address.



01) Press the **UP/DOWN** buttons until the display shows  IP Addr 00.000-0 .

02) Press the **SETUP** button to open the menu. The display will show  010.000, 000.000 .

- 03) Repeatedly press the **SETUP** button to skip to the desired section of the IP address (the currently selected section will blink).
- 04) Press the **UP/DOWN** buttons to set the values.
- 05) Press the **SETUP** button to confirm.
- 06) Keep pressing the **SETUP** button until the display returns to the previous menu.





### 5.3. Net Mask

With this menu you can set the net mask.

- 01) Press the **UP/DOWN** buttons until the display shows  .
- 02) Press the **SETUP** button to open the menu. The display will show  .
- 03) Repeatedly press the **SETUP** button to skip to the desired section of the net mask (the currently selected section will blink).
- 04) Press the **UP/DOWN** buttons to set the values.
- 05) Press the **SETUP** button to confirm.
- 06) Keep pressing the **SETUP** button until the display returns to the previous menu.



### 5.4. Net

With this menu you can set the net.

- 01) Press the **UP/DOWN** buttons until the display shows  .
- 02) Press the **SETUP** button to open the menu.
- 03) Press the **UP/DOWN** buttons to set the net value. The adjustment range is between    .
- 04) Press the **SETUP** button to confirm.



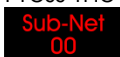

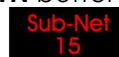
### 5.5. Subnet

With this menu you can set the subnet.

- 01) Press the **UP/DOWN** buttons until the display shows  .
- 02) Press the **SETUP** button to open the menu.
- 03) Press the **UP/DOWN** buttons to set the subnet value. The adjustment range is between    .
- 04) Press the **SETUP** button to confirm.



### 5.6. Universe

With this menu you can set the universe.

- 01) Press the **UP/DOWN** buttons until the display shows  .
- 02) Press the **SETUP** button to open the menu.
- 03) Press the **UP/DOWN** buttons to set the universe value. The adjustment range is between    .
- 04) Press the **SETUP** button to confirm.



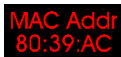

### 5.7. MAC Address

With this menu you can set the MAC address.

- 01) Press the **UP/DOWN** buttons until the display shows  .
- 02) Press the **SETUP** button to open the menu.
- 03) Press the **UP/DOWN** buttons to insert the password and to gain access to the menu. The password is **088**.
- 04) Press the **SETUP** button to confirm the password and enter the menu. The display will show  .
- 05) Repeatedly press the **SETUP** button to skip to the desired section of the MAC address (the currently selected section will blink).
- 07) Press the **UP/DOWN** buttons to set the values.
- 08) Press the **SETUP** button to confirm.
- 09) Keep pressing the **SETUP** button until the display returns to the previous menu.

## 6. Sound-controlled

With this menu you can set sound-controlled mode.

- 1) Press the **MODE** button until the display shows  .
- 2) Press the **UP/DOWN** buttons to set the sound sensitivity. The adjustment range is between    , from OFF to high sound sensitivity.
- 3) Press the **SETUP** button to confirm.
- 4) The device will now react to the beat of the background music.

## 7. Static Colors

With this menu you can set the device's static colors.

- 1) Press the **MODE** button until the display shows  .
- 2) Press the **SETUP** button to open the menu.
- 3) Repeatedly press the **SETUP** button to toggle through the 3 colors: Red, Green and Blue.
- 4) Once you have chosen the desired color, press the **UP/DOWN** buttons to set color brightness. The adjustment range for each color is between 0-255, from dark to brightest.
- 5) You can combine Red, Green and Blue (0-255) to create an infinite range of colors.

## 8. Settings

With this menu you can adjust the device's settings.

- 1) Press the **MODE** button until the display shows  .
- 2) Press the **SETUP** button to open the menu.
- 3) Press the **UP/DOWN** buttons to choose one of the 4 options below.

### 8.1. LED Mode

With this menu you can set the desired LED strip length: 50 cm or 100 cm.

- 1) When the display shows  , press the **SETUP** button to open the menu.
- 2) Press the **UP/DOWN** buttons to choose between 1.0M and 0.5M.
- 3) Press the **SETUP** button to confirm.

### 8.2. DMX Error Menu

With this menu you can determine the device's behavior in case of a DMX signal error.

- 1) When the display shows  , press the **SETUP** button to open the menu.
- 2) Press the **UP/DOWN** buttons to choose between OFF and HOLD.
- 3) If you have chosen OFF, the device will black out, when a DMX signal error occurs.
- 4) If you have chosen HOLD, the device will fall back on the last properly working DMX signal from before the DMX signal error, which ensures uninterrupted performance.
- 5) Press the **SETUP** button to confirm.

### 8.3. Display Settings

- 1) When the display shows  , press the **SETUP** button to open the menu.
- 2) Press the **UP/DOWN** buttons to choose one of the following options: 10s, 20s, 30s, 60s (the display will turn off when no button is pressed within the preset amount of time) or ON (the display will remain continuously on).

### 8.4. Reset

With this menu you can restore the factory settings.

- 1) When the display shows  , press the **SETUP** button to open the menu.
- 2) Press the **UP/DOWN** buttons to choose between YES and NO.
- 3) If you have chosen YES, press the **SETUP** button to confirm. The device will now restore the default settings and will return to the main menu.





04) If you have chosen NO, press the **SETUP** button to confirm and the device will return to the previous menu.

## 9. Software Information

With this menu you can monitor the current software version.

01) Press the **MODE** button until the display shows  .

02) Press the **SETUP** button to open the menu. The display will show  .

03) Press the **SETUP** button again to view the software version. The display will show  .

## DMX Channels

### 6 channels

#### Channel 1 – Color Macros

0-5	Not functional
6-11	Color 1
12-17	Color 2
18-23	Color 3
24-29	Color 4
30-35	Color 5
36-41	Color 6
42-47	Color 7
48-53	Color 8
54-59	Color 9
60-65	Color 10
66-71	Color 11
72-77	Color 12
78-83	Color 13
84-89	Color 14
90-95	Color 15
96-101	Color 16
102-107	Color 17
108-113	Color 18
114-119	Color 19
120-125	Color 20
126-131	Color 21
132-137	Color 22
138-143	Color 23
144-149	Color 24
150-155	Color 25
156-161	Color 26
162-167	Color 27
168-173	Color 28
174-179	Color 29
180-185	Color 30
186-191	Color 31
192-197	Color 32
198-203	Color 33
204-209	Color 34
210-215	Color 35
216-221	Color 36
222-227	Color 37
228-233	Color 38
234-255	Color 39

**Channel 2 – Red** ⚠ **CH1 must be closed** ⚠  
0-255 Gradual adjustment Red, from 0-100%

**Channel 3 – Green** ⚠ **CH1 must be closed** ⚠  
0-255 Gradual adjustment Green, from 0-100%

**Channel 4 – Blue** ⚠ **CH1 must be closed** ⚠  
0-255 Gradual adjustment Blue, from 0-100%

**Channel 5 – Strobe**  
0-4 Not functional  
5-255 Strobe frequency, from low to high frequency

**Channel 6 – Sound sensitivity** ⚠ **CH1 must be closed** ⚠  
0-255 Sound sensitivity adjustment, from OFF to high sensitivity

### 8 channels

**Channel 1 – Dimmer**  
0-255 Dimmer intensity, from dark to brightest

**Channel 2 – Strobe**  
0-4 Not functional  
5-255 Strobe frequency, from low to high frequency

**Channel 3 – Built-in programs** ⚠ **Dimmer must be open** ⚠

0-10	Not functional
11-22	Program 1
23-34	Program 2
35-46	Program 3
47-58	Program 4
59-70	Program 5
71-82	Program 6
83-94	Program 7
95-106	Program 8
107-118	Program 9
119-130	Program 10
131-142	Program 11
143-154	Program 12
155-166	Program 13
167-178	Program 14
179-190	Program 15
191-202	Program 16
203-214	Program 17
215-226	Program 18
227-238	Program 19
239-250	Program 20
251-255	Sound-controlled mode

**Channel 4 – Program speed** ⚠ **CH3 must be set between 11-250** ⚠  
0-255 Speed adjustment, from slow to fast

**Channel 4 – Sound sensitivity** ⚠ **CH3 must be set between 251-255** ⚠  
0-255 Sound sensitivity adjustment, from low to high sensitivity

**Channel 5 – Color Macros  CH1 must be open and CH3 must be closed **

0-5	Not functional
6-11	Color 1
12-17	Color 2
18-23	Color 3
24-29	Color 4
30-35	Color 5
36-41	Color 6
42-47	Color 7
48-53	Color 8
54-59	Color 9
60-65	Color 10
66-71	Color 11
72-77	Color 12
78-83	Color 13
84-89	Color 14
90-95	Color 15
96-101	Color 16
102-107	Color 17
108-113	Color 18
114-119	Color 19
120-125	Color 20
126-131	Color 21
132-137	Color 22
138-143	Color 23
144-149	Color 24
150-155	Color 25
156-161	Color 26
162-167	Color 27
168-173	Color 28
174-179	Color 29
180-185	Color 30
186-191	Color 31
192-197	Color 32
198-203	Color 33
204-209	Color 34
210-215	Color 35
216-221	Color 36
222-227	Color 37
228-233	Color 38
234-255	Color 39

**Channel 6 – Red  CH1 must be open and CH3 and CH5 must be closed **

0-255 Gradual adjustment Red, from 0-100%

**Channel 7 – Green  CH1 must be open and CH3 and CH5 must be closed **

0-255 Gradual adjustment Green, from 0-100%

**Channel 8 – Blue  CH1 must be open and CH3 and CH5 must be closed **

0-255 Gradual adjustment Blue, from 0-100%

**14 channels****Channel 1 – Built-in programs**

0-10	Not functional
11-22	Program 1
23-34	Program 2
35-46	Program 3
47-58	Program 4
59-70	Program 5
71-82	Program 6
83-94	Program 7
95-106	Program 8
107-118	Program 9
119-130	Program 10
131-142	Program 11
143-154	Program 12
155-166	Program 13
167-178	Program 14
179-190	Program 15
191-202	Program 16
203-214	Program 17
215-226	Program 18
227-238	Program 19
239-250	Program 20
251-255	Sound-controlled mode

**Channel 2 – Program speed ⚠ CH1 must be set between 11-250 ⚠**

0-255	Speed adjustment, from slow to fast
-------	-------------------------------------

**Channel 2 – Sound sensitivity ⚠ CH1 must be set between 251-255 ⚠**

0-255	Sound sensitivity adjustment, from low to high sensitivity
-------	--

**Channel 3 – Dimmer, LED strips 1–4**

0-255	Dimmer intensity, from dark to brightest
-------	--

**Channel 4 – Strobe, LED strips 1–4**

0-4	Not functional
5-255	Strobe frequency, from low to high frequency

**Channel 5 – Color Macros, LED strips 1–4 ⚠ CH3 must be open and CH1 must be closed ⚠**

0-5	Not functional
6-11	Color 1
12-17	Color 2
18-23	Color 3
24-29	Color 4
30-35	Color 5
36-41	Color 6
42-47	Color 7
48-53	Color 8
54-59	Color 9
60-65	Color 10
66-71	Color 11
72-77	Color 12
78-83	Color 13
84-89	Color 14
90-95	Color 15
96-101	Color 16

102-107	Color 17
108-113	Color 18
114-119	Color 19
120-125	Color 20
126-131	Color 21
132-137	Color 22
138-143	Color 23
144-149	Color 24
150-155	Color 25
156-161	Color 26
162-167	Color 27
168-173	Color 28
174-179	Color 29
180-185	Color 30
186-191	Color 31
192-197	Color 32
198-203	Color 33
204-209	Color 34
210-215	Color 35
216-221	Color 36
222-227	Color 37
228-233	Color 38
234-255	Color 39

**Channel 6 – Red, LED strips 1–4 ⚠ CH3 must be open, CH5 must be closed ⚠**

0-255 Gradual adjustment Red, from 0-100%

**Channel 7 – Green, LED strips 1–4 ⚠ CH3 must be open, CH5 must be closed ⚠**

0-255 Gradual adjustment Green, from 0-100%

**Channel 8 – Blue, LED strips 1–4 ⚠ CH3 must be open, CH5 must be closed ⚠**

0-255 Gradual adjustment Blue, from 0-100%

**Channel 9 – Dimmer, LED strips 5–8**

0-255 Dimmer intensity, from dark to brightest

**Channel 10 – Strobe, LED strips 5–8**

0-4 Not functional

5-255 Strobe frequency, from low to high frequency

**Channel 11 – Color Macros, LED strips 5–8 ⚠ CH9 must be open and CH1 must be closed ⚠**

0-5 Not functional

6-11 Color 1

12-17 Color 2

18-23 Color 3

24-29 Color 4

30-35 Color 5

36-41 Color 6

42-47 Color 7

48-53 Color 8

54-59 Color 9

60-65 Color 10

66-71 Color 11

72-77 Color 12

78-83 Color 13

84-89 Color 14

90-95	Color 15
96-101	Color 16
102-107	Color 17
108-113	Color 18
114-119	Color 19
120-125	Color 20
126-131	Color 21
132-137	Color 22
138-143	Color 23
144-149	Color 24
150-155	Color 25
156-161	Color 26
162-167	Color 27
168-173	Color 28
174-179	Color 29
180-185	Color 30
186-191	Color 31
192-197	Color 32
198-203	Color 33
204-209	Color 34
210-215	Color 35
216-221	Color 36
222-227	Color 37
228-233	Color 38
234-255	Color 39

**Channel 12 – Red, LED strips 5–8 ⚠ CH9 must be open, CH11 must be closed ⚠**

0-255 Gradual adjustment Red, from 0-100%

**Channel 13 – Green, LED strips 5–8 ⚠ CH9 must be open, CH11 must be closed ⚠**

0-255 Gradual adjustment Green, from 0-100%

**Channel 14 – Blue, LED strips 5–8 ⚠ CH9 must be open, CH11 must be closed ⚠**

0-255 Gradual adjustment Blue, from 0-100%

**24 channels**

**Channel 1 – Red, LED strip 1**

0-255            Gradual adjustment Red, from 0-100%

**Channel 2 – Green, LED strip 1**

0-255            Gradual adjustment Green, from 0-100%

**Channel 3 – Blue, LED strip 1**

0-255            Gradual adjustment Blue, from 0-100%

**Channel 4 – Red, LED strip 2**

0-255            Gradual adjustment Red, from 0-100%

**Channel 5 – Green, LED strip 2**

0-255            Gradual adjustment Green, from 0-100%

**Channel 6 – Blue, LED strip 2**

0-255            Gradual adjustment Blue, from 0-100%

**Channel 7 – Red, LED strip 3**

0-255            Gradual adjustment Red, from 0-100%

**Channel 8 – Green, LED strip 3**

0-255            Gradual adjustment Green, from 0-100%

**Channel 9 – Blue, LED strip 3**

0-255            Gradual adjustment Blue, from 0-100%

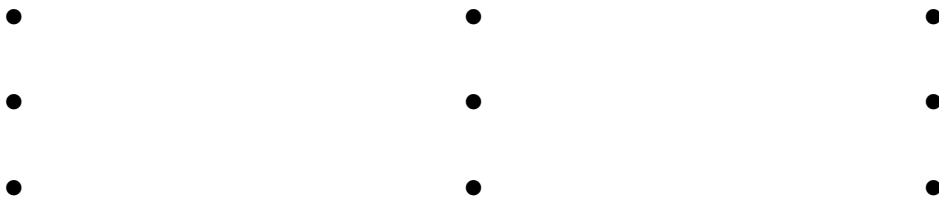

**Channel 22 – Red, LED strip 8**

0-255            Gradual adjustment Red, from 0-100%

**Channel 23 – Green, LED strip 8**

0-255            Gradual adjustment Green, from 0-100%

**Channel 24 – Blue, LED strip 8**

0-255            Gradual adjustment Blue, from 0-100%



## 26 channels

### Channel 1 – Built-in programs

0-10	Not functional
11-22	Program 1
23-34	Program 2
35-46	Program 3
47-58	Program 4
59-70	Program 5
71-82	Program 6
83-94	Program 7
95-106	Program 8
107-118	Program 9
119-130	Program 10
131-142	Program 11
143-154	Program 12
155-166	Program 13
167-178	Program 14
179-190	Program 15
191-202	Program 16
203-214	Program 17
215-226	Program 18
227-238	Program 19
239-250	Program 20
251-255	Sound-controlled mode

### Channel 2 – Program speed CH1 must be set between 11-250

0-255	Speed adjustment, from slow to fast
-------	-------------------------------------

### Channel 2 – Sound sensitivity CH1 must be set between 251-255

0-255	Sound sensitivity adjustment, from low to high sensitivity
-------	--

### Channel 3 – Dimmer, LED strips 1-2

0-255	Dimmer intensity, from dark to brightest
-------	--

### Channel 4 – Strobe, LED strips 1-2

0-4	Not functional
5-255	Strobe frequency, from low to high frequency

### Channel 5 – Color Macros, LED strips 1-2 CH3 must be open and CH1 must be closed

0-5	Not functional
6-11	Color 1
12-17	Color 2
18-23	Color 3
24-29	Color 4
30-35	Color 5
36-41	Color 6
42-47	Color 7
48-53	Color 8
54-59	Color 9
60-65	Color 10
66-71	Color 11
72-77	Color 12
78-83	Color 13
84-89	Color 14
90-95	Color 15
96-101	Color 16

102-107	Color 17
108-113	Color 18
114-119	Color 19
120-125	Color 20
126-131	Color 21
132-137	Color 22
138-143	Color 23
144-149	Color 24
150-155	Color 25
156-161	Color 26
162-167	Color 27
168-173	Color 28
174-179	Color 29
180-185	Color 30
186-191	Color 31
192-197	Color 32
198-203	Color 33
204-209	Color 34
210-215	Color 35
216-221	Color 36
222-227	Color 37
228-233	Color 38
234-255	Color 39

**Channel 6 – Red, LED strips 1-2 ⚠ CH3 must be open, CH1 and CH5 must be closed ⚠**

0-255 Gradual adjustment Red, from 0-100%

**Channel 7 – Green, LED strips 1-2 ⚠ CH3 must be open, CH1 and CH5 must be closed ⚠**

0-255 Gradual adjustment Green, from 0-100%

**Channel 8 – Blue, LED strips 1-2 ⚠ CH3 must be open, CH1 and CH5 must be closed ⚠**

0-255 Gradual adjustment Blue, from 0-100%

**Channel 9 – Dimmer, LED strips 3-4**

0-255 Dimmer intensity, from dark to brightest

**Channel 10 – Strobe, LED strips 3-4**

0-4 Not functional

5-255 Strobe frequency, from low to high frequency

**Channel 11 – Color Macros, LED strips 3-4 ⚠ CH9 must be open and CH1 must be closed ⚠**

0-5 Not functional

6-11 Color 1

12-17 Color 2

18-23 Color 3

24-29 Color 4

30-35 Color 5

36-41 Color 6

42-47 Color 7

48-53 Color 8

54-59 Color 9

60-65 Color 10

66-71 Color 11

72-77 Color 12

78-83 Color 13

84-89 Color 14

90-95	Color 15
96-101	Color 16
102-107	Color 17
108-113	Color 18
114-119	Color 19
120-125	Color 20
126-131	Color 21
132-137	Color 22
138-143	Color 23
144-149	Color 24
150-155	Color 25
156-161	Color 26
162-167	Color 27
168-173	Color 28
174-179	Color 29
180-185	Color 30
186-191	Color 31
192-197	Color 32
198-203	Color 33
204-209	Color 34
210-215	Color 35
216-221	Color 36
222-227	Color 37
228-233	Color 38
234-255	Color 39

**Channel 12 – Red, LED strips 3–4** ⚠️ **CH9 must be open, CH1 and CH11 must be closed** ⚠️  
 0-255 Gradual adjustment Red, from 0-100%

**Channel 13 – Green, LED strips 3–4** ⚠️ **CH9 must be open, CH1 and CH11 must be closed** ⚠️  
 0-255 Gradual adjustment Green, from 0-100%

**Channel 14 – Blue, LED strips 3–4** ⚠️ **CH9 must be open, CH1 and CH11 must be closed** ⚠️  
 0-255 Gradual adjustment Blue, from 0-100%

**Channel 15 – Dimmer, LED strips 5–6**  
 0-255 Dimmer intensity, from dark to brightest

**Channel 16 – Strobe, LED strips 5–6**  
 0-4 Not functional  
 5-255 Strobe frequency, from low to high frequency

**Channel 17 – Color Macros, LED strips 5–6** ⚠️ **CH15 must be open and CH1 must be closed** ⚠️

0-5	Not functional
6-11	Color 1
12-17	Color 2
18-23	Color 3
24-29	Color 4
30-35	Color 5
36-41	Color 6
42-47	Color 7
48-53	Color 8
54-59	Color 9
60-65	Color 10
66-71	Color 11
72-77	Color 12

78-83	Color 13
84-89	Color 14
90-95	Color 15
96-101	Color 16
102-107	Color 17
108-113	Color 18
114-119	Color 19
120-125	Color 20
126-131	Color 21
132-137	Color 22
138-143	Color 23
144-149	Color 24
150-155	Color 25
156-161	Color 26
162-167	Color 27
168-173	Color 28
174-179	Color 29
180-185	Color 30
186-191	Color 31
192-197	Color 32
198-203	Color 33
204-209	Color 34
210-215	Color 35
216-221	Color 36
222-227	Color 37
228-233	Color 38
234-255	Color 39

**Channel 18 – Red, LED strips 5–6** ⚠️ **CH15 must be open, CH1 and CH17 must be closed** ⚠️  
 0-255 Gradual adjustment Red, from 0-100%

**Channel 19 – Green, LED strips 5–6** ⚠️ **CH15 must be open, CH1 and CH17 must be closed** ⚠️  
 0-255 Gradual adjustment Green, from 0-100%

**Channel 20 – Blue, LED strips 5–6** ⚠️ **CH15 must be open, CH1 and CH17 must be closed** ⚠️  
 0-255 Gradual adjustment Blue, from 0-100%

**Channel 21 – Dimmer, LED strips 7–8**  
 0-255 Dimmer intensity, from dark to brightest

**Channel 22 – Strobe, LED strips 7–8**  
 0-4 Not functional  
 5-255 Strobe frequency, from low to high frequency

**Channel 23 – Color Macros, LED strips 7–8** ⚠️ **CH21 must be open and CH1 must be closed** ⚠️  
 0-5 Not functional  
 6-11 Color 1  
 12-17 Color 2  
 18-23 Color 3  
 24-29 Color 4  
 30-35 Color 5  
 36-41 Color 6  
 42-47 Color 7  
 48-53 Color 8  
 54-59 Color 9  
 60-65 Color 10

66-71	Color 11
72-77	Color 12
78-83	Color 13
84-89	Color 14
90-95	Color 15
96-101	Color 16
102-107	Color 17
108-113	Color 18
114-119	Color 19
120-125	Color 20
126-131	Color 21
132-137	Color 22
138-143	Color 23
144-149	Color 24
150-155	Color 25
156-161	Color 26
162-167	Color 27
168-173	Color 28
174-179	Color 29
180-185	Color 30
186-191	Color 31
192-197	Color 32
198-203	Color 33
204-209	Color 34
210-215	Color 35
216-221	Color 36
222-227	Color 37
228-233	Color 38
234-255	Color 39

**Channel 24 – Red, LED strips 7-8 ⚠ CH21 must be open, CH1 and CH23 must be closed ⚠**  
0-255 Gradual adjustment Red, from 0-100%

**Channel 25 – Green, LED strips 7-8 ⚠ CH21 must be open, CH1 and CH23 must be closed ⚠**  
0-255 Gradual adjustment Green, from 0-100%

**Channel 26 – Blue, LED strips 7-8 ⚠ CH21 must be open, CH1 and CH23 must be closed ⚠**  
0-255 Gradual adjustment Blue, from 0-100%

**50 channels****Channel 1 – Built-in programs**

0-10	Not functional
11-22	Program 1
23-34	Program 2
35-46	Program 3
47-58	Program 4
59-70	Program 5
71-82	Program 6
83-94	Program 7
95-106	Program 8
107-118	Program 9
119-130	Program 10
131-142	Program 11
143-154	Program 12
155-166	Program 13
167-178	Program 14
179-190	Program 15
191-202	Program 16
203-214	Program 17
215-226	Program 18
227-238	Program 19
239-250	Program 20
251-255	Sound-controlled mode

**Channel 2 – Program speed  CH1 must be set between 11-250 **

0-255	Speed adjustment, from slow to fast
-------	-------------------------------------

**Channel 2 – Sound sensitivity  CH1 must be set between 251-255 **

0-255	Sound sensitivity adjustment, from low to high sensitivity
-------	--

**Channel 3 – Dimmer, LED strip 1**

0-255	Dimmer intensity, from dark to brightest
-------	--

**Channel 4 – Strobe, LED strip 1**

0-4	Not functional
5-255	Strobe frequency, from low to high frequency

**Channel 5 – Color Macros, LED strip 1  CH3 must be open and CH1 must be closed **

0-5	Not functional
6-11	Color 1
12-17	Color 2
18-23	Color 3
24-29	Color 4
30-35	Color 5
36-41	Color 6
42-47	Color 7
48-53	Color 8
54-59	Color 9
60-65	Color 10
66-71	Color 11
72-77	Color 12
78-83	Color 13
84-89	Color 14
90-95	Color 15
96-101	Color 16

102-107	Color 17
108-113	Color 18
114-119	Color 19
120-125	Color 20
126-131	Color 21
132-137	Color 22
138-143	Color 23
144-149	Color 24
150-155	Color 25
156-161	Color 26
162-167	Color 27
168-173	Color 28
174-179	Color 29
180-185	Color 30
186-191	Color 31
192-197	Color 32
198-203	Color 33
204-209	Color 34
210-215	Color 35
216-221	Color 36
222-227	Color 37
228-233	Color 38
234-255	Color 39

**Channel 6 – Red, LED strip 1  CH3 must be open, CH1 and CH5 must be closed **

0-255 Gradual adjustment Red, from 0-100%

**Channel 7 – Green, LED strip 1  CH3 must be open, CH1 and CH5 must be closed **

0-255 Gradual adjustment Green, from 0-100%

**Channel 8 – Blue, LED strip 1  CH3 must be open, CH1 and CH5 must be closed **

0-255 Gradual adjustment Blue, from 0-100%

**Channel 9 – Dimmer, LED strip 2**

0-255 Dimmer intensity, from dark to brightest

**Channel 10 – Strobe, LED strip 2**

0-4 Not functional

5-255 Strobe frequency, from low to high frequency

**Channel 11 – Color Macros, LED strip 2  CH9 must be open and CH1 must be closed **

0-5 Not functional

6-11 Color 1

12-17 Color 2

18-23 Color 3

24-29 Color 4

30-35 Color 5

36-41 Color 6

42-47 Color 7

48-53 Color 8

54-59 Color 9

60-65 Color 10

66-71 Color 11

72-77 Color 12

78-83 Color 13

84-89 Color 14



90-95	Color 15
96-101	Color 16
102-107	Color 17
108-113	Color 18
114-119	Color 19
120-125	Color 20
126-131	Color 21
132-137	Color 22
138-143	Color 23
144-149	Color 24
150-155	Color 25
156-161	Color 26
162-167	Color 27
168-173	Color 28
174-179	Color 29
180-185	Color 30
186-191	Color 31
192-197	Color 32
198-203	Color 33
204-209	Color 34
210-215	Color 35
216-221	Color 36
222-227	Color 37
228-233	Color 38
234-255	Color 39

**Channel 12 – Red, LED strip 2** ⚠️ **CH9 must be open, CH1 and CH11 must be closed** ⚠️  
 0-255 Gradual adjustment Red, from 0-100%

**Channel 13 – Green, LED strip 2** ⚠️ **CH9 must be open, CH1 and CH11 must be closed** ⚠️  
 0-255 Gradual adjustment Green, from 0-100%

**Channel 14 – Blue, LED strip 2** ⚠️ **CH9 must be open, CH1 and CH11 must be closed** ⚠️  
 0-255 Gradual adjustment Blue, from 0-100%

**Channel 15 – Dimmer, LED strip 3**  
 0-255 Dimmer intensity, from dark to brightest

**Channel 16 – Strobe, LED strip 3**  
 0-4 Not functional  
 5-255 Strobe frequency, from low to high frequency

**Channel 17 – Color Macros, LED strip 3** ⚠️ **CH15 must be open and CH1 must be closed** ⚠️

0-5	Not functional
6-11	Color 1
12-17	Color 2
18-23	Color 3
24-29	Color 4
30-35	Color 5
36-41	Color 6
42-47	Color 7
48-53	Color 8
54-59	Color 9
60-65	Color 10
66-71	Color 11
72-77	Color 12

78-83	Color 13
84-89	Color 14
90-95	Color 15
96-101	Color 16
102-107	Color 17
108-113	Color 18
114-119	Color 19
120-125	Color 20
126-131	Color 21
132-137	Color 22
138-143	Color 23
144-149	Color 24
150-155	Color 25
156-161	Color 26
162-167	Color 27
168-173	Color 28
174-179	Color 29
180-185	Color 30
186-191	Color 31
192-197	Color 32
198-203	Color 33
204-209	Color 34
210-215	Color 35
216-221	Color 36
222-227	Color 37
228-233	Color 38
234-255	Color 39

**Channel 18 – Red, LED strip 3** ⚠️ **CH15 must be open, CH1 and CH17 must be closed** ⚠️  
 0-255 Gradual adjustment Red, from 0-100%

**Channel 19 – Green, LED strip 3** ⚠️ **CH15 must be open, CH1 and CH17 must be closed** ⚠️  
 0-255 Gradual adjustment Green, from 0-100%

**Channel 20 – Blue, LED strip 3** ⚠️ **CH15 must be open, CH1 and CH17 must be closed** ⚠️  
 0-255 Gradual adjustment Blue, from 0-100%

**Channel 21 – Dimmer, LED strip 4**  
 0-255 Dimmer intensity, from dark to brightest

**Channel 22 – Strobe, LED strip 4**  
 0-4 Not functional  
 5-255 Strobe frequency, from low to high frequency

**Channel 23 – Color Macros, LED strip 4** ⚠️ **CH21 must be open and CH1 must be closed** ⚠️  
 0-5 Not functional  
 6-11 Color 1  
 12-17 Color 2  
 18-23 Color 3  
 24-29 Color 4  
 30-35 Color 5  
 36-41 Color 6  
 42-47 Color 7  
 48-53 Color 8  
 54-59 Color 9  
 60-65 Color 10

66-71	Color 11
72-77	Color 12
78-83	Color 13
84-89	Color 14
90-95	Color 15
96-101	Color 16
102-107	Color 17
108-113	Color 18
114-119	Color 19
120-125	Color 20
126-131	Color 21
132-137	Color 22
138-143	Color 23
144-149	Color 24
150-155	Color 25
156-161	Color 26
162-167	Color 27
168-173	Color 28
174-179	Color 29
180-185	Color 30
186-191	Color 31
192-197	Color 32
198-203	Color 33
204-209	Color 34
210-215	Color 35
216-221	Color 36
222-227	Color 37
228-233	Color 38
234-255	Color 39

**Channel 24 – Red, LED strip 4** ⚠️ **CH21 must be open, CH1 and CH23 must be closed** ⚠️  
 0-255 Gradual adjustment Red, from 0-100%

**Channel 25 – Green, LED strip 4** ⚠️ **CH21 must be open, CH1 and CH23 must be closed** ⚠️  
 0-255 Gradual adjustment Green, from 0-100%

**Channel 26 – Blue, LED strip 4** ⚠️ **CH21 must be open, CH1 and CH23 must be closed** ⚠️  
 0-255 Gradual adjustment Blue, from 0-100%

**Channel 27 – Dimmer, LED strip 5**  
 0-255 Dimmer intensity, from dark to brightest

**Channel 28 – Strobe, LED strip 5**  
 0-4 Not functional  
 5-255 Strobe frequency, from low to high frequency

**Channel 29 – Color Macros, LED strip 5** ⚠️ **CH27 must be open and CH1 must be closed** ⚠️  
 0-5 Not functional  
 6-11 Color 1  
 12-17 Color 2  
 18-23 Color 3  
 24-29 Color 4  
 30-35 Color 5  
 36-41 Color 6  
 42-47 Color 7  
 48-53 Color 8

54-59	Color 9
60-65	Color 10
66-71	Color 11
72-77	Color 12
78-83	Color 13
84-89	Color 14
90-95	Color 15
96-101	Color 16
102-107	Color 17
108-113	Color 18
114-119	Color 19
120-125	Color 20
126-131	Color 21
132-137	Color 22
138-143	Color 23
144-149	Color 24
150-155	Color 25
156-161	Color 26
162-167	Color 27
168-173	Color 28
174-179	Color 29
180-185	Color 30
186-191	Color 31
192-197	Color 32
198-203	Color 33
204-209	Color 34
210-215	Color 35
216-221	Color 36
222-227	Color 37
228-233	Color 38
234-255	Color 39

**Channel 30 – Red, LED strip 5** ⚠ **CH27 must be open, CH1 and CH29 must be closed** ⚠  
 0-255 Gradual adjustment Red, from 0-100%

**Channel 31 – Green, LED strip 5** ⚠ **CH27 must be open, CH1 and CH29 must be closed** ⚠  
 0-255 Gradual adjustment Green, from 0-100%

**Channel 32 – Blue, LED strip 5** ⚠ **CH27 must be open, CH1 and CH29 must be closed** ⚠  
 0-255 Gradual adjustment Blue, from 0-100%

**Channel 33 – Dimmer, LED strip 6**  
 0-255 Dimmer intensity, from dark to brightest

**Channel 34 – Strobe, LED strip 6**  
 0-4 Not functional  
 5-255 Strobe frequency, from low to high frequency

**Channel 35 – Color Macros, LED strip 6** ⚠ **CH33 must be open and CH1 must be closed** ⚠  
 0-5 Not functional  
 6-11 Color 1  
 12-17 Color 2  
 18-23 Color 3  
 24-29 Color 4  
 30-35 Color 5  
 36-41 Color 6

42-47	Color 7
48-53	Color 8
54-59	Color 9
60-65	Color 10
66-71	Color 11
72-77	Color 12
78-83	Color 13
84-89	Color 14
90-95	Color 15
96-101	Color 16
102-107	Color 17
108-113	Color 18
114-119	Color 19
120-125	Color 20
126-131	Color 21
132-137	Color 22
138-143	Color 23
144-149	Color 24
150-155	Color 25
156-161	Color 26
162-167	Color 27
168-173	Color 28
174-179	Color 29
180-185	Color 30
186-191	Color 31
192-197	Color 32
198-203	Color 33
204-209	Color 34
210-215	Color 35
216-221	Color 36
222-227	Color 37
228-233	Color 38
234-255	Color 39

**Channel 36 – Red, LED strip 6** ⚠ **CH33 must be open, CH1 and CH35 must be closed** ⚠  
 0-255 Gradual adjustment Red, from 0-100%

**Channel 37 – Green, LED strip 6** ⚠ **CH33 must be open, CH1 and CH35 must be closed** ⚠  
 0-255 Gradual adjustment Green, from 0-100%

**Channel 38 – Blue, LED strip 6** ⚠ **CH33 must be open, CH1 and CH35 must be closed** ⚠  
 0-255 Gradual adjustment Blue, from 0-100%

**Channel 39 – Dimmer, LED strip 7**  
 0-255 Dimmer intensity, from dark to brightest

**Channel 40 – Strobe, LED strip 7**  
 0-4 Not functional  
 5-255 Strobe frequency, from low to high frequency

**Channel 41 – Color Macros, LED strip 7** ⚠ **CH39 must be open and CH1 must be closed** ⚠  
 0-5 Not functional  
 6-11 Color 1  
 12-17 Color 2  
 18-23 Color 3  
 24-29 Color 4

30-35	Color 5
36-41	Color 6
42-47	Color 7
48-53	Color 8
54-59	Color 9
60-65	Color 10
66-71	Color 11
72-77	Color 12
78-83	Color 13
84-89	Color 14
90-95	Color 15
96-101	Color 16
102-107	Color 17
108-113	Color 18
114-119	Color 19
120-125	Color 20
126-131	Color 21
132-137	Color 22
138-143	Color 23
144-149	Color 24
150-155	Color 25
156-161	Color 26
162-167	Color 27
168-173	Color 28
174-179	Color 29
180-185	Color 30
186-191	Color 31
192-197	Color 32
198-203	Color 33
204-209	Color 34
210-215	Color 35
216-221	Color 36
222-227	Color 37
228-233	Color 38
234-255	Color 39

**Channel 42 – Red, LED strip 7** ⚠️ **CH39 must be open, CH1 and CH41 must be closed** ⚠️  
 0-255 Gradual adjustment Red, from 0-100%

**Channel 43 – Green, LED strip 7** ⚠️ **CH39 must be open, CH1 and CH41 must be closed** ⚠️  
 0-255 Gradual adjustment Green, from 0-100%

**Channel 44 – Blue, LED strip 7** ⚠️ **CH39 must be open, CH1 and CH41 must be closed** ⚠️  
 0-255 Gradual adjustment Blue, from 0-100%

**Channel 45 – Dimmer, LED strip 8**  
 0-255 Dimmer intensity, from dark to brightest

**Channel 46 – Strobe, LED strip 8**  
 0-4 Not functional  
 5-255 Strobe frequency, from low to high frequency

**Channel 47 – Color Macros, LED strip 8  CH45 must be open and CH1 must be closed **

0-5	Not functional
6-11	Color 1
12-17	Color 2
18-23	Color 3
24-29	Color 4
30-35	Color 5
36-41	Color 6
42-47	Color 7
48-53	Color 8
54-59	Color 9
60-65	Color 10
66-71	Color 11
72-77	Color 12
78-83	Color 13
84-89	Color 14
90-95	Color 15
96-101	Color 16
102-107	Color 17
108-113	Color 18
114-119	Color 19
120-125	Color 20
126-131	Color 21
132-137	Color 22
138-143	Color 23
144-149	Color 24
150-155	Color 25
156-161	Color 26
162-167	Color 27
168-173	Color 28
174-179	Color 29
180-185	Color 30
186-191	Color 31
192-197	Color 32
198-203	Color 33
204-209	Color 34
210-215	Color 35
216-221	Color 36
222-227	Color 37
228-233	Color 38
234-255	Color 39

**Channel 48 – Red, LED strip 8  CH45 must be open, CH1 and CH47 must be closed **

0-255 Gradual adjustment Red, from 0-100%

**Channel 49 – Green, LED strip 8  CH45 must be open, CH1 and CH47 must be closed **

0-255 Gradual adjustment Green, from 0-100%

**Channel 50 – Blue, LED strip 8  CH45 must be open, CH1 and CH47 must be closed **

0-255 Gradual adjustment Blue, from 0-100%





There are 8 x 50 cm LED strips connected to the Octostrip.  
Each 50 cm LED strip is divided into 4 separate sections.  
Each section is equipped with 3 color LEDs (RGB).



8 LED strips x 4 sections x 3 colors = 96 channels.

**96 channels (only when using the 50 cm LED strips)**

**Channel 1 – Red, LED strip 1, section 1**

0-255 Gradual adjustment Red, from 0-100%

**Channel 2 – Green, LED strip 1, section 1**

0-255 Gradual adjustment Green, from 0-100%

**Channel 3 – Blue, LED strip 1, section 1**

0-255 Gradual adjustment Blue, from 0-100%

**Channel 4 – Red, LED strip 1, section 2**

0-255 Gradual adjustment Red, from 0-100%

**Channel 5 – Green, LED strip 1, section 2**

0-255 Gradual adjustment Green, from 0-100%

**Channel 6 – Blue, LED strip 1, section 2**

0-255 Gradual adjustment Blue, from 0-100%

**Channel 7 – Red, LED strip 1, section 3**

0-255 Gradual adjustment Red, from 0-100%

**Channel 8 – Green, LED strip 1, section 3**

0-255 Gradual adjustment Green, from 0-100%

**Channel 9 – Blue, LED strip 1, section 3**

0-255 Gradual adjustment Blue, from 0-100%

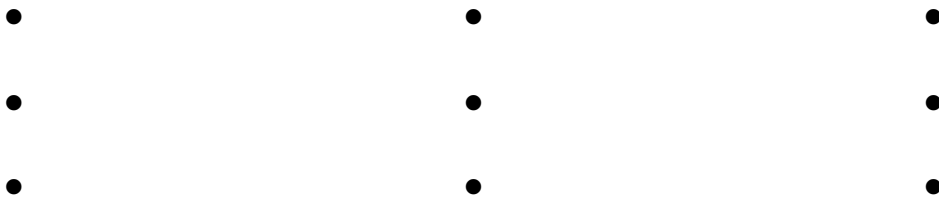

**Channel 94 – Red, LED strip 8, section 4**

0-255 Gradual adjustment Red, from 0-100%

**Channel 95 – Green, LED strip 8, section 4**

0-255 Gradual adjustment Green, from 0-100%

**Channel 96 – Blue, LED strip 8, section 4**

0-255 Gradual adjustment Blue, from 0-100%





**There are 8 x 50 cm LED strips connected to the Octostrip.**  
**Each 50 cm LED strip has its own dimmer and strobe.**  
**Each 50 cm LED strip is divided into 4 separate sections.**  
**Each section is equipped with 3 color LEDs (RGB).**



**8 LED strips x 4 sections x 3 colors + 8 dimmers + 8 strobes = 112 channels.**

**112 channels (only when using the 50 cm LED strips)**

**Channel 1 – Dimmer, LED strip 1**

0-255            Dimmer intensity, from dark to brightest

**Channel 2 – Strobe, LED strip 1**

0-4             Not functional

5-255          Strobe frequency, from low to high frequency

**Channel 3 – Dimmer, LED strip 2**

0-255           Dimmer intensity, from dark to brightest

**Channel 4 – Strobe, LED strip 2**

0-4             Not functional

5-255          Strobe frequency, from low to high frequency

**Channel 5 – Dimmer, LED strip 3**

0-255           Dimmer intensity, from dark to brightest

**Channel 6 – Strobe, LED strip 3**

0-4             Not functional

5-255          Strobe frequency, from low to high frequency

**Channel 7 – Dimmer, LED strip 4**

0-255           Dimmer intensity, from dark to brightest

**Channel 8 – Strobe, LED strip 4**

0-4             Not functional

5-255          Strobe frequency, from low to high frequency

**Channel 9 – Dimmer, LED strip 5**

0-255           Dimmer intensity, from dark to brightest

**Channel 10 – Strobe, LED strip 5**

0-4             Not functional

5-255          Strobe frequency, from low to high frequency

**Channel 11 – Dimmer, LED strip 6**

0-255           Dimmer intensity, from dark to brightest

**Channel 12 – Strobe, LED strip 6**

0-4             Not functional

5-255          Strobe frequency, from low to high frequency

**Channel 13 – Dimmer, LED strip 7**

0-255           Dimmer intensity, from dark to brightest

**Channel 14 – Strobe, LED strip 7**

0-4 Not functional  
5-255 Strobe frequency, from low to high frequency

**Channel 15 – Dimmer, LED strip 8**

0-255 Dimmer intensity, from dark to brightest

**Channel 16 – Strobe, LED strip 8**

0-4 Not functional  
5-255 Strobe frequency, from low to high frequency

**Channel 17 – Red, LED strip 1, section 1 ⚠ CH1 must be open ⚠**

0-255 Gradual adjustment Red, from 0-100%

**Channel 18 – Green, LED strip 1, section 1 ⚠ CH1 must be open ⚠**

0-255 Gradual adjustment Green, from 0-100%

**Channel 19 – Blue, LED strip 1, section 1 ⚠ CH1 must be open ⚠**

0-255 Gradual adjustment Blue, from 0-100%

**Channel 20 – Red, LED strip 1, section 2 ⚠ CH1 must be open ⚠**

0-255 Gradual adjustment Red, from 0-100%

**Channel 21 – Green, LED strip 1, section 2 ⚠ CH1 must be open ⚠**

0-255 Gradual adjustment Green, from 0-100%

**Channel 22 – Blue, LED strip 1, section 2 ⚠ CH1 must be open ⚠**

0-255 Gradual adjustment Blue, from 0-100%

**Channel 23 – Red, LED strip 1, section 3 ⚠ CH1 must be open ⚠**

0-255 Gradual adjustment Red, from 0-100%

**Channel 24 – Green, LED strip 1, section 3 ⚠ CH1 must be open ⚠**

0-255 Gradual adjustment Green, from 0-100%

**Channel 25 – Blue, LED strip 1, section 3 ⚠ CH1 must be open ⚠**

0-255 Gradual adjustment Blue, from 0-100%

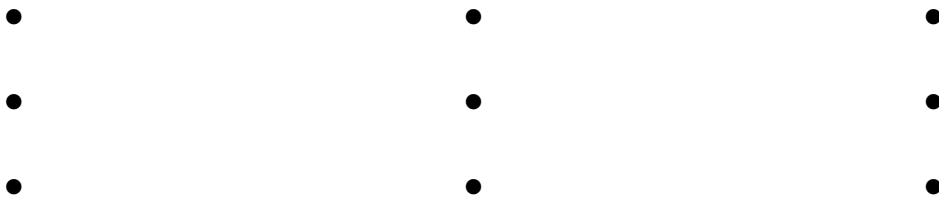

**Channel 110 – Red, LED strip 8, section 4 ⚠ CH15 must be open ⚠**

0-255 Gradual adjustment Red, from 0-100%

**Channel 111 – Green, LED strip 8, section 4 ⚠ CH15 must be open ⚠**

0-255 Gradual adjustment Green, from 0-100%

**Channel 112 – Blue, LED strip 8, section 4 ⚠ CH15 must be open ⚠**

0-255 Gradual adjustment Blue, from 0-100%

1	2	3	4	5	6	7	8
---	---	---	---	---	---	---	---

There are 8 x 100 cm LED strips connected to the Octostrip.  
 Each 100 cm LED strip is divided into 8 separate sections.  
 Each section is equipped with 3 color LEDs (RGB).



8 LED strips x 8 sections x 3 colors = 192 channels.

**192 channels (only when using the 100 cm LED strips)**

**Channel 1 – Red, LED strip 1, section 1**

0-255 Gradual adjustment Red, from 0-100%

**Channel 2 – Green, LED strip 1, section 1**

0-255 Gradual adjustment Green, from 0-100%

**Channel 3 – Blue, LED strip 1, section 1**

0-255 Gradual adjustment Blue, from 0-100%

**Channel 4 – Red, LED strip 1, section 2**

0-255 Gradual adjustment Red, from 0-100%

**Channel 5 – Green, LED strip 1, section 2**

0-255 Gradual adjustment Green, from 0-100%

**Channel 6 – Blue, LED strip 1, section 2**

0-255 Gradual adjustment Blue, from 0-100%

**Channel 7 – Red, LED strip 1, section 3**

0-255 Gradual adjustment Red, from 0-100%

**Channel 8 – Green, LED strip 1, section 3**

0-255 Gradual adjustment Green, from 0-100%

**Channel 9 – Blue, LED strip 1, section 3**

0-255 Gradual adjustment Blue, from 0-100%

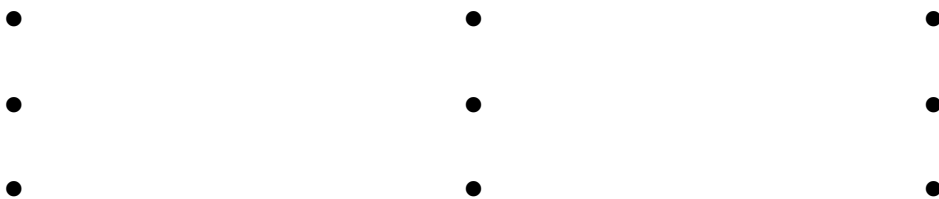

**Channel 190 – Red, LED strip 8, section 8**

0-255 Gradual adjustment Red, from 0-100%

**Channel 191 – Green, LED strip 8, section 8**

0-255 Gradual adjustment Green, from 0-100%

**Channel 192 – Blue, LED strip 8, section 8**

0-255 Gradual adjustment Blue, from 0-100%

1	2	3	4	5	6	7	8
---	---	---	---	---	---	---	---

There are 8 x 100 cm LED strips connected to the Octostrip.  
 Each 100 cm LED strip has its own dimmer and strobe.  
 Each 100 cm LED strip is divided into 8 separate sections.  
 Each section is equipped with 3 color LEDs (RGB).



8 LED strips x 8 sections x 3 colors + 8 dimmers + 8 strobes = 208 channels.

**208 channels (only when using the 100 cm LED strips)**

**Channel 1 – Dimmer, LED strip 1**

0-255 Dimmer intensity, from dark to brightest

**Channel 2 – Strobe, LED strip 1**

0-4 Not functional

5-255 Strobe frequency, from low to high frequency

**Channel 3 – Dimmer, LED strip 2**

0-255 Dimmer intensity, from dark to brightest

**Channel 4 – Strobe, LED strip 2**

0-4 Not functional

5-255 Strobe frequency, from low to high frequency

**Channel 5 – Dimmer, LED strip 3**

0-255 Dimmer intensity, from dark to brightest

**Channel 6 – Strobe, LED strip 3**

0-4 Not functional

5-255 Strobe frequency, from low to high frequency

**Channel 7 – Dimmer, LED strip 4**

0-255 Dimmer intensity, from dark to brightest

**Channel 8 – Strobe, LED strip 4**

0-4 Not functional

5-255 Strobe frequency, from low to high frequency

**Channel 9 – Dimmer, LED strip 5**

0-255 Dimmer intensity, from dark to brightest

**Channel 10 – Strobe, LED strip 5**

0-4 Not functional

5-255 Strobe frequency, from low to high frequency

**Channel 11 – Dimmer, LED strip 6**

0-255 Dimmer intensity, from dark to brightest

**Channel 12 – Strobe, LED strip 6**

0-4 Not functional

5-255 Strobe frequency, from low to high frequency

**Channel 13 – Dimmer, LED strip 7**

0-255 Dimmer intensity, from dark to brightest

## Channel 14 – Strobe, LED strip 7

0-4	Not functional
5-255	Strobe frequency, from low to high frequency

## Channel 15 – Dimmer, LED strip 8

0-255	Dimmer intensity, from dark to brightest
-------	--

## Channel 16 – Strobe, LED strip 8

0-4	Not functional
5-255	Strobe frequency, from low to high frequency

## Channel 17 – Red, LED strip 1, section 1 CH1 must be open

0-255	Gradual adjustment Red, from 0-100%
-------	-------------------------------------

## Channel 18 – Green, LED strip 1, section 1 CH1 must be open

0-255	Gradual adjustment Green, from 0-100%
-------	---------------------------------------

## Channel 19 – Blue, LED strip 1, section 1 CH1 must be open

0-255	Gradual adjustment Blue, from 0-100%
-------	--------------------------------------

## Channel 20 – Red, LED strip 1, section 2 CH1 must be open

0-255	Gradual adjustment Red, from 0-100%
-------	-------------------------------------

## Channel 21 – Green, LED strip 1, section 2 CH1 must be open

0-255	Gradual adjustment Green, from 0-100%
-------	---------------------------------------

## Channel 22 – Blue, LED strip 1, section 2 CH1 must be open

0-255	Gradual adjustment Blue, from 0-100%
-------	--------------------------------------

## Channel 23 – Red, LED strip 1, section 3 CH1 must be open

0-255	Gradual adjustment Red, from 0-100%
-------	-------------------------------------

## Channel 24 – Green, LED strip 1, section 3 CH1 must be open

0-255	Gradual adjustment Green, from 0-100%
-------	---------------------------------------

## Channel 25 – Blue, LED strip 1, section 3 CH1 must be open

0-255	Gradual adjustment Blue, from 0-100%
-------	--------------------------------------

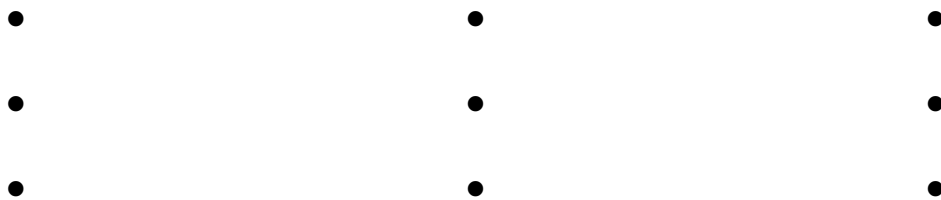

## Channel 206 – Red, LED strip 8, section 8 CH15 must be open

0-255	Gradual adjustment Red, from 0-100%
-------	-------------------------------------

## Channel 207 – Green, LED strip 8, section 8 CH15 must be open

0-255	Gradual adjustment Green, from 0-100%
-------	---------------------------------------

## Channel 208 – Blue, LED strip 8, section 8 CH15 must be open

0-255	Gradual adjustment Blue, from 0-100%
-------	--------------------------------------

## Maintenance

---

The operator has to make sure that safety-related and machine-technical installations are to be inspected by an expert after every year in the course of an acceptance test.

The operator has to make sure that safety-related and machine-technical installations are to be inspected by a skilled person once a year.

The following points have to be considered during the inspection:

- 01) All screws used for installing the device or parts of the device have to be tightly connected and must not be corroded.
- 02) There may not be any deformations on housings, fixations and installation spots.
- 03) Mechanically moving parts like axles, eyes and others may not show any traces of wearing.
- 04) The electric power supply cables must not show any damages or material fatigue.

The LED Octostrip Set MKII 50 cm requires almost no maintenance. However, you should keep the unit clean. Otherwise, the fixture's light output will be significantly reduced. Disconnect the mains power supply, and then wipe the cover with a damp cloth. Do not immerse in liquid. Do not use alcohol or solvents. Please clean internal components once a year with a light brush and vacuum cleaner. Keep connections clean. Disconnect electric power, and then wipe the DMX connections with a damp cloth. Make sure connections are thoroughly dry before linking equipment or supplying electric power.

## Replacing the Fuse

Power surges, short-circuit or inappropriate electrical power supply may cause a fuse to burn out. If the fuse burns out, the product will not function whatsoever. If this happens, follow the directions below.

- 01) Unplug the unit from electric power source.
- 02) Insert a screwdriver into the slot in the fuse cover. Turn the fuse holder counterclockwise. The fuse will come out.
- 03) Remove the used fuse. If brown or unclear, it is burned out.
- 04) Insert the replacement fuse into the holder where the old fuse was. Reinsert the fuse holder. Be sure to use a fuse of the same type and specification. See the product specification label for details.

## Troubleshooting

---

This troubleshooting guide is meant to help solve simple problems.

If a problem occurs, carry out the steps below in sequence until a solution is found. Once the unit operates properly, do not carry out following steps.

### No Light

If the light effect does not operate properly, refer servicing to a technician.

Suspect three potential problem areas as: the power supply, the fuse and the LEDs.

- 01) Power supply. Check that the unit is plugged into an appropriate power supply.
- 02) The fuse. Replace the fuse. See page 49 for replacing the fuse.
- 03) The LEDs. Return the LED Octostrip Set MKII 50 cm to your Showtec dealer.
- 04) If all of the above appears to be O.K., plug the unit in again.
- 05) If you are unable to determine the cause of the problem, do not open the LED Octostrip Set MKII 50 cm, as this may damage the unit and the warranty will become void.
- 06) Return the device to your Showtec dealer.

**No Response to DMX**

Suspect the DMX cable or connectors, a controller malfunction, a light effect DMX card malfunction.

- 01) Check the DMX setting. Make sure that DMX addresses are correct.
- 02) Check the DMX cable: Unplug the unit; change the DMX cable; then reconnect to electrical power. Try your DMX control again.
- 03) Determine whether the controller or light effect is at fault. Does the controller operate properly with other DMX products? If not, take the controller in for repair. If so, take the DMX cable and the light effect to a qualified technician.

<b>Problem</b>	<b>Probable cause(s)</b>	<b>Solution</b>
One or more fixtures do not function at all	No power to the fixture	<ul style="list-style-type: none"> <li>• Check if power is switched on and cables are plugged in</li> </ul>
	Primary fuse blown	<ul style="list-style-type: none"> <li>• Replace the fuse.</li> </ul>
Fixtures reset correctly, but all respond erratically or not at all to the controller	The controller is not connected.	<ul style="list-style-type: none"> <li>• Connect controller.</li> </ul>
	3-pin XLR Out of the controller does not match XLR Out of the first fixture on the link (i.e. signal is reversed)	<ul style="list-style-type: none"> <li>• Install a phase reversing cable between the controller and the first fixture on the link</li> </ul>
Fixtures reset correctly, but some respond erratically or not at all to the controller	Poor data quality	<ul style="list-style-type: none"> <li>• Check data quality. If much lower than 100 percent, the problem may be a bad data link connection, poor quality or broken cables, missing termination plug, or a defective fixture disturbing the link</li> </ul>
	Bad data link connection	<ul style="list-style-type: none"> <li>• Inspect connections and cables. Correct poor connections. Repair or replace damaged cables</li> </ul>
	Data link not terminated with 120 Ohm termination plug	<ul style="list-style-type: none"> <li>• Insert termination plug in output jack of the last fixture on the link</li> </ul>
	Incorrect addressing of the fixtures	<ul style="list-style-type: none"> <li>• Check address setting</li> </ul>
	One of the fixtures is defective and disturbs data transmission on the link	<ul style="list-style-type: none"> <li>• Bypass one fixture at a time until normal operation is restored: unplug both connectors and connect them directly together.</li> <li>• Have the defective fixture serviced by a qualified technician</li> </ul>
	3-pin XLR Out on the fixtures does not match (pins 2 and 3 reversed)	<ul style="list-style-type: none"> <li>• Install a phase-reversing cable between the fixtures or swap pin 2 and 3 in the fixture that behaves erratically</li> </ul>
No light or LEDs cut out intermittently	Fixture is too hot	<ul style="list-style-type: none"> <li>• Allow the fixture to cool down</li> <li>• Make sure air vents are not blocked</li> <li>• Turn up the air conditioning</li> </ul>
	LEDs damaged	<ul style="list-style-type: none"> <li>• Disconnect the fixture and return it to your dealer</li> </ul>
	The power supply settings do not match local AC voltage and frequency	<ul style="list-style-type: none"> <li>• Disconnect fixture. Check settings and correct if necessary</li> </ul>



## Product Specifications

Model:	Showtec LED Octostrip Set MKII 50 cm
Input voltage:	100-240V AC, 50/60Hz
Power consumption:	52W (full output)
DMX linking:	30pcs
Fuse:	T2L/250V
Dimensions (controller):	200 x 315 x 92 mm (LxWxH)
Dimensions (LED strip):	500 x 30 x 50 mm (LxWxH)
Weight (controller):	2,5 kg
Weight (8 x LED strips):	8 x 0,8 kg
<b>Operating and Programming:</b>	
Signal pin OUT:	Pin 1 (earth), pin 2 (-), pin 3 (+)
DMX Mode:	6, 8, 14, 26, 50, 96, 112, 192, 208 channels
Signal input:	3-pin DMX/RJ45 IN
Signal output:	3-pin DMX/RJ45 OUT
LED strip output:	5-pin XLR OUT
<b>Electro-mechanical effects:</b>	
Dimmer:	0-100%
Strobe:	0-20Hz
Housing:	Die-cast aluminum
Control protocol:	DMX-512, ArtNet
DMX control:	via standard DMX controller
Onboard:	LED display for easy setup
Control:	Auto, Built-in programs, Sound-controlled, Static Colors, Master/Slave, DMX/ArtNet
IP rating:	IP20
Connections:	Dedicated Pro power to Schuko & data connectors
Cooling:	Convection
Max. ambient temperature $t_a$ :	40°C
Max. housing temperature $t_B$ :	80°C
<b>Minimum distance:</b>	
Minimum distance from flammable surfaces:	0,5 m
Minimum distance to lighted object:	1 m

Design and product specifications are subject to change without prior notice.



Website: [www.Showtec.info](http://www.Showtec.info)

Email: [service@highlite.nl](mailto:service@highlite.nl)



## Dimensions

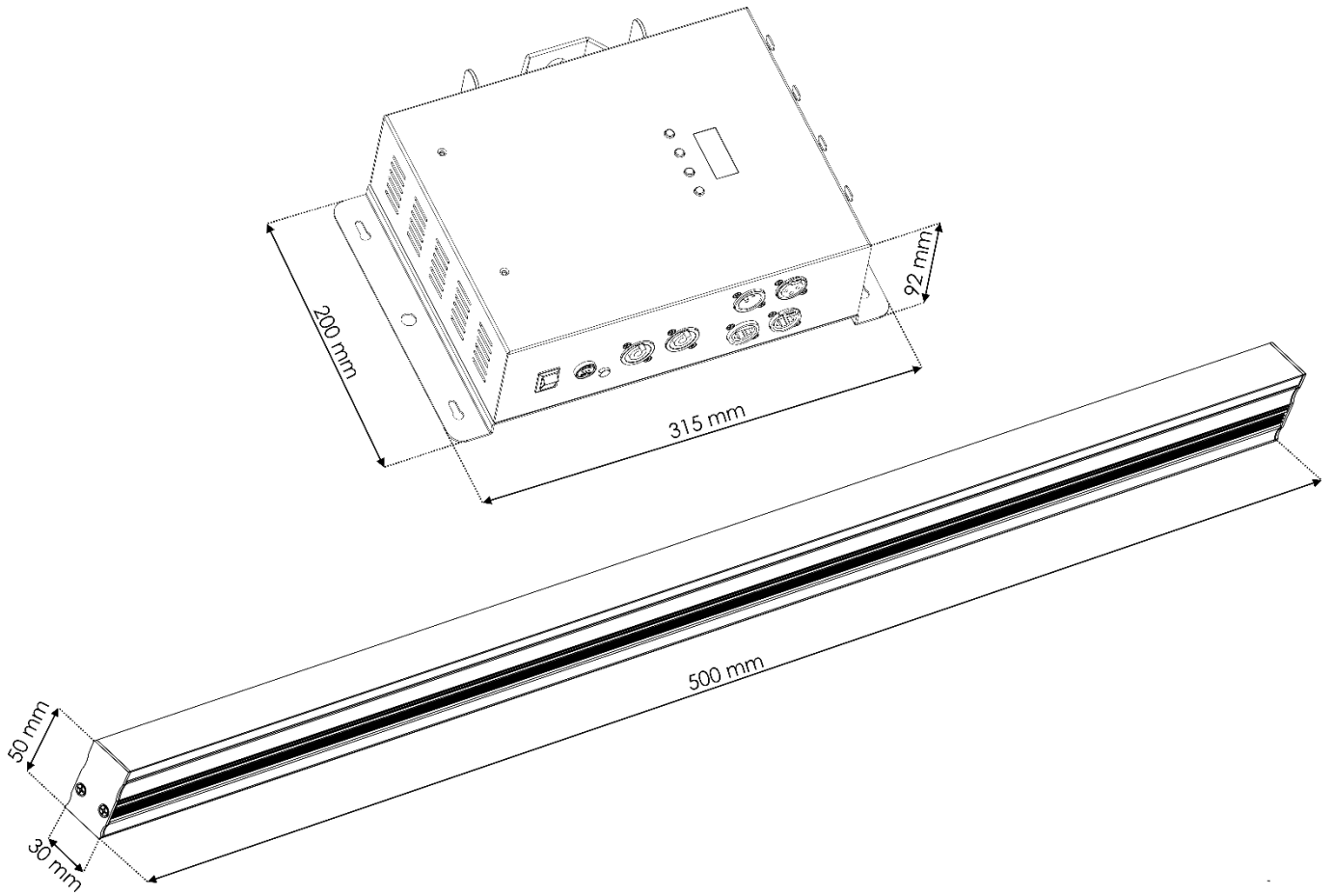







©2018 Showtec